

Welch Allyn Connex[®] Devices



Directions for use

Software versions 2.0X–2.2X

WelchAllyn[®]

Advancing Frontline Care[™]

© 2014 Welch Allyn. All rights are reserved. To support the intended use of the product described in this publication, the purchaser of the product is permitted to copy this publication, for internal distribution only, from the media provided by Welch Allyn. No other use, reproduction, or distribution of this publication, or any part of it, is permitted without written permission from Welch Allyn. Welch Allyn assumes no responsibility for any injury to anyone, or for any illegal or improper use of the product, that may result from failure to use this product in accordance with the instructions, cautions, warnings, or statement of intended use published in this manual.

Welch Allyn, Connex, SureTemp, FlexiPort, and SureBP are registered trademarks of Welch Allyn.

Vital Signs Monitor 6000 Series and PartnerConnect are trademarks of Welch Allyn.

Integrated Pulmonary Index is a trademark of , and Oridion and Microstream are registered trademarks of, Oridion Medical 1987 Ltd. No implied license. Possession or purchase of this device does not convey any express or implied license to use the device with unauthorized CO2 sampling products which would, alone, or in combination with this device, fall within the scope of one or more of the patents relating to this device and/or CO2 sampling products.

Radical-7R, Pulse CO-Oximeter, rainbow Acoustic Monitoring, RRa, and ReSposable are trademarks of, and SET, LNCS, SpHb, rainbow, and Masimo are registered trademarks of, Masimo Corporation. Possession or purchase of a Masimo-equipped device does not convey any express or implied license to use the device with unauthorized sensors or cables which would, alone or in combination with this device, fall within the scope of one or more of the patents relating to this device.

Nellcor and OxiMax are registered trademarks of Nellcor Puritan Bennett Inc.

Braun and ThermoScan are registered trademarks of Braun GmbH.

Health o meter is a registered trademark of Sunbeam Products, Inc., used under license.

EarlySense is a registered trademark of EarlySense Ltd.

Software in this product is Copyright 2014 Welch Allyn or its vendors. All rights are reserved. The software is protected by United States of America copyright laws and international treaty provisions applicable worldwide. Under such laws, the licensee is entitled to use the copy of the software incorporated with this instrument as intended in the operation of the product in which it is embedded. The software may not be copied, decompiled, reverse-engineered, disassembled, or otherwise reduced to human-perceivable form. This is not a sale of the software or any copy of the software; all right, title, and ownership of the software remain with Welch Allyn or its vendors.

For patent information, please visit www.welchallyn.com/patents.

For information about any Welch Allyn product, contact Welch Allyn Technical Support: www.welchallyn.com/about/company/locations.htm.

DIR 80019390 Ver. A

This manual applies to **REF** 901060 Vital Signs Monitor and **REF** 901028 Connex Integrated Wall System.



Welch Allyn, Inc.
4341 State Street Road
Skaneateles Falls, NY 13153-0220 USA

www.welchallyn.com

EC REP

Regulatory Affairs Representative
Welch Allyn Limited
Navan Business Park
Dublin Road
Navan, County Meath
Republic of Ireland

EarlySense

Masimo SET
rainbow

NELCOR
OXIMAX
WORKS
HERE

Oridion

BRAUN

WelchAllyn®

Advancing Frontline Care™

Contents

Introduction	1
Connex Vital Signs Monitor 6000 Series	1
Connex Integrated Wall System	1
Indications for use	2
Contraindications	3
Symbols	5
Screen elements	9
About warnings and cautions	15
General warnings and cautions	15
Physical design	21
Vital Signs Monitor 6000 Series	21
Integrated Wall System	25
Setup	29
Vital Signs Monitor 6000 Series	29
Supplies and accessories	29
Insert the battery	29
Mount the monitor	30
Attach the probe well	31
Attach the temperature probe	32
Remove the temperature probe and well	32
Connect the NIBP hose	33
Disconnect the NIBP hose	33
Connect the SpO2 cable or the SpO2/RRa dual cable	33
Disconnect the SpO2 cable or the SpO2/RRa dual cable	35
Connect the patient movement cable	35
Disconnect the patient movement sensor and cable	36
Attach a USB accessory	36
Detach a USB accessory	37
Insert a new roll of paper	37
Connect AC power	38
Disconnect AC power	38
Integrated Wall System	39
Supplies and accessories	39
Unpack the wall system	39
Insert the battery	40
Prepare for mounting	41
Mounting location	42
Mount the wall system	42

Mount the accessory bin	46
Connect the blood pressure (NIBP) hose	47
Set up the physical assessment instrument handles and specula dispenser ...	48
Set up the SureTemp® Plus thermometer	49
Set up the Braun ThermoScan® PRO 4000 thermometer	49
Connect AC power	50
Attach an accessory	51
Startup	53
Power	53
Power up the monitor	54
Change the language	55
Set the date and time	55
Power down the monitor	56
Reset the monitor	56
Enter clinician information	56
Navigation	59
Home tab	59
Device Status area	59
Content area	62
Navigation area	63
Using the keypad, keyboard, and barcode scanner	65
Open the numeric keypad	65
Numeric keypad	65
Enter a number	66
Close the numeric keypad	66
Open the keyboard	66
Keyboard	66
Enter a letter or number	68
Enter a symbol or special character	68
Enter a diacritical mark	68
Close the keyboard	69
Use a barcode scanner	69
Connex CS	71
Overview	71
Monitor tab	72
Connect to the central station	73
Disconnect from the central station	73
Continuous patient monitoring	74
Activate the Continuous Monitoring profile	74
Pause continuous monitoring (Pause mode)	75
Resume continuous monitoring	76
End continuous monitoring	76
Assign a patient and location	77
Profiles	79
Continuous Monitoring profile	79
Saving vital sign measurements (Continuous Monitoring profile)	81
Intervals Monitoring profile	81
Spot Check profile	82

Triage profile	82
Profile feature comparison	83
Changing profiles	83
Patient data management	89
Add a patient to the patient list	89
Load patient data with a barcode scanner	90
Select a patient	90
Manage patient records (Continuous Monitoring profile)	92
Manage patient records (Intervals Monitoring, Spot Check, and Triage profiles)	94
Printer	95
Delete a patient from the list	95
Alarms	97
Patient rest mode	99
Reset (pause or turn off) audio alarms	100
Cancel a paused alarm	102
Adjust vital sign alarm limits	102
Modify audio alarm notification	103
Alarm messages and priorities	104
Nurse call	108
Patient monitoring	109
Standard and custom modifiers	109
Custom scoring	110
Manual overrides	110
Patient movement	110
Capnography (CO ₂)	116
Respiration rate	120
IPI	122
Acoustic respiration rate (RRa)	125
NIBP	128
Temperature	139
SpO ₂	151
SpHb	157
Pulse rate frame	161
Manual parameters frame	163
Physical assessment instrument handles	164
Maintenance and service	167
Vital Signs Monitor 6000 Series	167
Perform periodic checks	167
Replace the printer paper	167
Change the battery	168
Clean the monitor	170
Clean the accessories	171
Clean the stand	171
Integrated Wall System	172
Perform periodic checks	172
Remove the wall system from the wall	172
Change the battery	174
Clean the wall system (excluding handle cradles and accessories)	175

Clean the handle cradles	176
Clean the wall system accessories	176
Advanced settings	177
General	177
Parameters	182
Data management	187
Network	190
Service	193
Troubleshooting	195
Patient movement messages	195
CO2 messages	197
RRa messages	198
NIBP messages	199
SpO2 and SpHb messages	200
Temperature messages	201
Weight scale messages	202
Physical assessment instrument handles	202
Patient data management messages	203
Communications module messages	204
Radio messages	204
Ethernet messages	204
USB and USB flash drive messages	204
System messages	205
Battery power manager messages	205
Configuration Manager messages	206
Printer messages	206
Network messages	207
Problems and solutions	207
Specifications	209
Physical specifications	209
Environmental specifications	221
Monitor radio	222
Configuration options	223
Vital Signs Monitor 6000 Series	223
Integrated Wall System	223
Standards and compliance	225
General compliance and standards	225
General radio compliance	226
Guidance and manufacturer's declaration	229
EMC compliance	229
Emissions and immunity information	229
Appendix	231
Approved accessories	231
Warranty	243

Introduction

This directions for use covers the following devices:

- the Connex Vital Signs Monitor 6000 Series
- the Connex Integrated Wall System

Most of the content in this directions for use applies to both Connex devices, but some sections present device-specific content. See section titles and parentheses throughout to identify the device-specific content.

Connex Vital Signs Monitor 6000 Series

This directions for use describes the capabilities and operation of the monitor. The information, including the illustrations, covers all configuration options. If your monitor configuration lacks any of these options, some information in this manual might not apply.

Before using the monitor, you must familiarize yourself with all warnings and cautions, with the steps to power up the monitor, and with the sections of this directions for use that pertain to your use of the monitor. You must also familiarize yourself with all information that accompanies the accessories you use.

Note Some product features described in this publication might not be available in your country. For the latest information about products and features, please call Welch Allyn Customer Care.

Connex Integrated Wall System

The Welch Allyn Connex® Integrated Wall System combines the advanced, easy-to-use monitor capabilities of the Welch Allyn Connex® Vital Signs Monitor 6000 Series with the Welch Allyn 767 Power Handles. This manual (directions for use) is designed to help you understand the capabilities and operation of the wall system. The information in this manual, including the illustrations, is based on a wall system configured with non-invasive blood pressure (NIBP), body temperature, pulse oximetry (SpO₂), total hemoglobin concentration (SpHb), pulse rate, weight scale, and two power handles. If your wall system configuration lacks any of these options, some information in this manual may not apply.

Before using the wall system, read the sections of the manual that pertain to your use of the system.

Note Throughout this directions for use, the Integrated Wall System may be referred to as a wall system or monitor.

Note Some product features described in this publication might not be available in your country. For the latest information about products and features, please call Welch Allyn Customer Care.

Indications for use

The Connex VSM 6000 series of monitors is intended to be used by clinicians and medically qualified personnel for monitoring of neonatal, pediatric, and adult patients for

- noninvasive blood pressure (NIBP)
- pulse rate (PR)
- noninvasive functional oxygen saturation of arteriolar hemoglobin (SpO₂)
- body temperature in normal and axillary modes

The most likely locations for patients to be monitored are general medical and surgical floors, general hospital, and alternate care environments. Monitoring can be accomplished on the VSM 6000 series bedside monitor itself, and the VSM 6000 series bedside monitor also can transmit data continuously for secondary remote viewing and alarming (e.g., at a central station). Secondary remote viewing and alarming features are intended to supplement and not replace any patient bedside monitoring procedures.

The optional Masimo rainbow® SET Pulse CO-Oximeter™ and accessories are indicated for the continuous noninvasive monitoring of functional oxygen saturation of arterial hemoglobin (SpO₂), pulse rate (PR), total hemoglobin concentration (SpHb®), and/or respiration rate (RRa™). The Masimo rainbow SET Radical-7R™ Pulse CO-Oximeter and accessories are indicated for use with adult, pediatric, and neonatal patients during both motion and no-motion conditions, and for patients who are well or poorly perfused in hospitals and hospital-type facilities.

The optional Oridion® module and accessories are intended for the continuous noninvasive measurement and monitoring of carbon dioxide concentration of the expired and inspired breath (etCO₂ and FiCO₂) and respiration rate (RR). It is intended for use with neonatal, pediatric, and adult patients in hospitals and hospital-type facilities.

The optional Oridion module also provides the clinician with an Integrated Pulmonary Index™ (IPI). The IPI is based on four parameters provided by the monitor: end-tidal carbon dioxide (etCO₂), respiration rate (RR), oxygen saturation (SpO₂), and pulse rate (PR). The IPI is a single index of an adult or pediatric patient's ventilatory status displayed on a scale of 1–10, where 10 indicates optimal pulmonary status. IPI monitoring displays a single value that represents the patient's pulmonary parameters and alerts clinicians to changes in the patient's pulmonary status.

The IPI is an adjunct to, and is not intended to replace, vital signs monitoring.

Optional compatible weight scales (e.g., Health o meter®) can be used for height, weight, and BMI input.

The optional EarlySense® (Everon) System is intended for continuous measurement of respiration rate, heart rate, and movement in an automatic contact-less manner, in a hospital or clinic setting. The system is indicated for use in children, adolescents, and adults. The operation of the EarlySense has been studied in children (weight ≥ 10 Kg) and adults (weight < 111 Kg) during sleep and resting condition.

This product is available for sale only upon the order of a physician or licensed healthcare professional.

Handle module assembly (Integrated Wall System only)

Handles supply power to Welch Allyn 3.5V instruments.

Contraindications

This system (all configurations) is not intended to be used:

- on patients connected to heart/lung machines
- on patients being transported outside a healthcare facility
- within the controlled access area of MRI equipment
- in a hyperbaric chamber
- in the presence of flammable anesthetics
- in the presence of electrocauterization devices

For contraindications of SpO₂ and SpHb sensors, consult the sensor manufacturer's directions for use.

Systems configured with EarlySense are not intended to be used:

- on patients for whom proper positioning cannot be achieved or maintained
- on patients who do not meet the weight limits tested or specified

Symbols

Documentation symbols



WARNING The warning statements in this manual identify conditions or practices that could lead to illness, injury, or death.



CAUTION The caution statements in this manual identify conditions or practices that could result in damage to the equipment or other property, or loss of data. This definition applies to both yellow and black and white symbols.



WARNING Hot surface. Do not touch.



Follow the operating instructions/directions for use (DFU) — mandatory action.
A copy of the DFU is available on this website.
A printed copy of the DFU can be ordered from Welch Allyn for delivery within 7 days.

Power symbols



Power on/Display power-saving



Equipotential terminal



(on the display) monitor is plugged into Alternating Current power



Battery absent or faulty



(on the monitor, green indicator)
Alternating Current power present,
battery fully charged







Battery charge level









(on the monitor, amber indicator)
Alternating Current power present,
battery is charging















Battery cover







	Alternating Current (AC)		Rechargeable battery
	Li-ion battery		AC input power

Connectivity symbols

	USB		Ethernet RJ-45
	Wireless signal strength <ul style="list-style-type: none"> • Best (4 bars) • Good (3 bars) • Fair (2 bars) • Weak (1 bar) • No signal (no bars) • No connection (blank) 		Nurse call
	Connected to central station		Disconnected from central station

Miscellaneous symbols

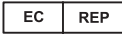
	CO2 sampling input		CO2 sampling output/exhaust
	Manufacturer		Limited rotation/Turn completely to right
	Reorder number		Serial number
	Do not reuse		China RoHS markings for control of pollution caused by electronic information products. XX indicates Environmentally Friendly Use Period in years.
	Nonionizing electromagnetic radiation		Recycle the product separate from other disposables
	Restrictions for use of wireless device in Europe. European Community's Class 2 radio equipment.		Call for maintenance

	Defibrillation-proof Type BF applied parts		Do not expose to open flame
	Altitude range		Not for injection
	Transport and storage temperature range		Authorized Representative of the European Community
	Recycle		

Screen elements

Global navigation, controls, and indicators



Select option

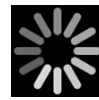

Process indicator for activities like acquiring measurements and connecting to a central station

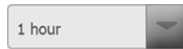

Select item from list



Display lock/unlock



Increase or decrease value

Monitoring and connectivity



Connect to the central station and retain patient data (Monitor tab)



Disconnect from the central station but continue monitoring and retain patient data (Monitor tab)



Connected to the central station (Device Status area)



Disconnected from the central station (Device Status area)

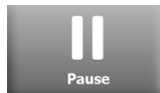

Temporarily pause continuous monitoring but retain patient data



End continuous monitoring session for current patient and clear patient data

NIBP



NIBP start



NIBP stop



Intervals status indicators



NIBP view toggle



Temperature



Temperature site control



Direct mode selector

SpO2 and Pulse rate



Pulse amplitude bar



SatSeconds timer (Nellcor feature only)



SpO2 view toggle



Response mode selector (Fast mode selected)



Pulse rate (in beats per minute)

Total hemoglobin (SpHb)



SpHbv view toggle



Averaging mode selector (Long mode selected)

Capnography (CO2)



CO2 pump start



CO2 pump stop

Capnography (CO2)



etCO2 view toggle



IPI view toggle

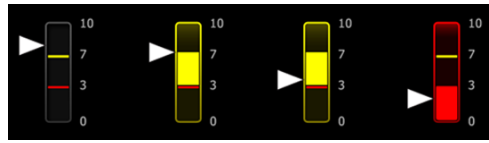

IPI graphic indicators

RRa



Respiration indicator



Averaging mode selector
(Fast mode selected)

Patient movement



Bed mode



Bed exit



Patient turn indicator and
timer



Bed exit (Review tab)



Patient turn indicator (Review
tab)







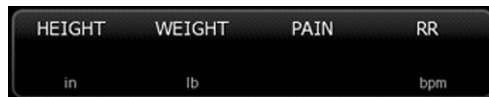

Exit sensitivity indicator

Manual parameters















Manual parameter selector

Alarm and information messages

	Alarm limit control		Alarm On/Off toggle
	Multiple alarms toggle		Alarm audio paused
	Alarm active		Information message
	Patient Rest Mode		

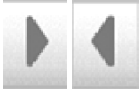
Patient data management

	Diacritical marks key (available for languages that use diacritical marks; appearance differs based on language)		Symbols key
	Send patient data		Print patient data/patient trend data
	Cancel action		Add patient identifiers
	Retrieve patient list from the network		Select patient from List tab
	Delete patient from List tab		Clear patient context from Summary tab
	Forward or backward in Review tab		Proceed to the next field to input patient information

Settings

Save as default

Save configuration settings

50
•○○

Select state or view

Save to USB

Save to USB flash drive

Configure from USB

Configure from USB flash drive

All settings

Restore factory default settings

Exit

Close Advanced settings

About warnings and cautions

Warning and caution statements can appear on the monitor, on the packaging, on the shipping container, or in this document.

The monitor is safe for patients and clinicians when used in accordance with the instructions and the warning and caution statements presented in this manual.

Before using the monitor, you must familiarize yourself with all warnings and cautions, with the steps to power up the monitor, and with the sections of this directions for use that pertain to your use of the monitor. In addition to reviewing the general warnings and cautions presented in the next section, you must also review the more specific warnings and cautions appear throughout the manual in conjunction with setup/startup, device operation, patient monitoring, and maintenance tasks.

- Failure to understand and observe any warning statement in this manual could lead to patient injury, illness, or death.
- Failure to understand and observe any caution statement in this manual could lead to damage to the equipment or other property, or loss of patient data.

General warnings and cautions



WARNING Many environmental variables, including patient physiology and clinical application, can affect the accuracy and performance of the monitor. Therefore, you must verify all vital signs information before treating the patient. If there is any question about the accuracy of a measurement, verify the measurement using another clinically accepted method.



WARNING Alarm limits are patient-specific. For alarms to function properly, you must set or verify alarm limits appropriate for each patient. Each time the monitor is powered on, you must check that the alarm settings are appropriate for your patient before you start monitoring.



WARNING The monitor is not intended for use during patient transport outside of the medical facility. Do not use the monitor to take measurements on any patient in transit.



WARNING Do not use the monitor as an apnea monitor. Neither the VSM 6000 series monitors, nor any of the integrated or accessory sensor systems used in conjunction with the VSM 6000 series monitors, are intended for use in apnea monitoring.



WARNING Use only Welch Allyn approved accessories, and use them according to the manufacturer's directions for use. Using unapproved accessories with the monitor can affect patient and operator safety and can compromise product performance and accuracy.



WARNING Inaccurate measurement risk. Do not connect more than one patient to a monitor.



WARNING Inaccurate measurement risk. Dust and particle ingress can affect the accuracy of blood pressure measurements. Use the monitor in clean environments to ensure measurement accuracy. If you notice dust or lint build-up on the monitor's vent openings, have the monitor inspected and cleaned by a qualified service technician.



WARNING Inaccurate measurement risk. Liquids and excessive moisture can damage patient sensors and cause them to perform inaccurately or fail.



WARNING Patient harm risk. Always remove sensors from patients and disconnect them completely from monitors before bathing.



WARNING Liquids can damage electronics inside the monitor. Prevent liquids from spilling on the monitor.
If liquids are spilled on the monitor:

1. Power down the monitor.
2. Disconnect the power plug.
3. Remove battery pack from the monitor.
4. Dry off excess liquid from the monitor.

Note If liquids possibly entered the monitor, remove the monitor from use until it has been properly dried, inspected, and tested by qualified service personnel.

5. Reinstall battery pack.
6. Power on the monitor and verify that the monitor functions normally before using it.

If liquids enter the printer housing:

1. Power down the monitor.
2. Disconnect the power plug.
3. Remove battery pack from the monitor.
4. Remove and discard the paper roll.
5. Clean and dry the inside of the printer housing.

Note The printer housing has a drain tube that directs liquids down and out the bottom of the monitor. If liquids possibly entered other openings in the monitor, remove the monitor from use until it has been properly dried, inspected, and tested by qualified service personnel.

6. Install a new roll of paper.
7. Power on the monitor and verify that the monitor functions normally before using it.



WARNING Safety risk and potential shock hazard. Cords, cables, and accessories damaged from prior misuse can affect patient and operator safety. Inspect all cords, cables, and accessories for strain relief wear, fraying, or other damage according to the recommendations presented in the Maintenance and service section of this manual. Replace as necessary. Inspect the AC cord for exposed copper before touching the cord. Unplug the AC cord only by pulling on the plug, never the cord. Never lift the monitor by the power cord or patient connections.



WARNING Fire and explosion hazard. Do not operate the monitor in the presence of a flammable anesthetic mixture with air, oxygen, or nitrous oxide; in oxygen-enriched environments; or in any other potentially explosive environment.



WARNING Fire and shock hazard. Only connect LAN cables contained within the perimeter of a single building. Conductive LAN cables spanning multiple buildings may introduce fire or shock hazards unless they are fitted with fiber optic cables, lightning arrestors, or other applicable safety features.



WARNING The monitor may not function properly if dropped or damaged. Protect it from severe impact and shock. Do not use the monitor if you notice any signs of damage. Qualified service personnel must check any monitor that is dropped or damaged for proper operation before putting the monitor back into use.



WARNING Defective batteries can damage the monitor. If the battery shows any signs of damage or cracking, it must be replaced immediately and only with a battery approved by Welch Allyn.



WARNING Improper disposal of batteries may create an explosion or contamination hazard. Never dispose of batteries in refuse containers. Always recycle batteries according to local regulations.



WARNING Electric shock hazard. Do not open the monitor or attempt repairs. The monitor has no user-serviceable internal parts. Only perform routine cleaning and maintenance procedures specifically described in this manual. Inspection and servicing of internal parts shall only be performed by qualified service personnel.



WARNING Inaccurate measurement risk. Do not expose to temperatures higher than 122° F (50° C).



WARNING Inaccurate measurement risk. Do not use the monitor on patients who are on heart-lung machines.



WARNING Inaccurate measurement risk. If using patient sensors during full body irradiation, keep the sensor out of the irradiation field. If the sensor is exposed to the irradiation, the reading might be inaccurate or the monitor might read zero during the active irradiation period.



WARNING Inaccurate measurement risk. Do not use the monitor on patients who are experiencing convulsions or tremors.



WARNING Use the monitor only as described in this directions for use. Do not use the monitor on patients as described in the Contraindications.



WARNING Personal/patient injury risk. Wall-mounted equipment and accessories must be installed in accordance with accompanying instructions. Improper installation can result in the monitor falling off the wall and injuring someone. Welch Allyn is not responsible for the integrity of any installation not performed by authorized Welch Allyn service personnel. Contact an authorized Welch Allyn service representative or other qualified service personnel to ensure professional installation for safety and reliability of any mounting accessory.



WARNING Do not place the monitor in any position that might cause it to fall on the patient.



WARNING Welch Allyn is not responsible for the integrity of a facility's power. If the integrity of a facility's power or protective earth conductor is in doubt, always operate the monitor on battery power alone when it is attached to a patient.



WARNING Avoid continuously monitoring a patient when the device is operating on battery power. If only battery power is available, you must remain in the room with any patient whose vital signs are being monitored continuously. Actively monitor both patient and battery status to ensure patient safety.



WARNING Patient harm and equipment damage risk. Carefully route patient cabling to reduce the possibility of patient entanglement or strangulation. When transporting the monitor on a mobile stand, properly secure all patient cables and cords to keep them clear of the wheels and to minimize trip hazards.



WARNING For operator and patient safety, peripheral equipment and accessories that can come in direct patient contact must comply with all applicable safety, EMC, and regulatory requirements.



WARNING All signal input and output (I/O) connectors are intended for connection of only devices complying with IEC 60601-1, or other IEC standards (for example, IEC 60950), as applicable to the monitor. Connecting additional devices to the monitor may increase chassis or patient leakage currents. To maintain operator and patient safety, consider the requirements of IEC 60601-1-1. Measure the leakage currents to confirm that no electric shock hazard exists.



WARNING Equipment failure and patient harm risk. Do not cover the air intake or exhaust vents on the rear and base of the monitor. Covering these vents could cause overheating of the monitor or muffling of alarms.



WARNING This equipment is not suitable for use in the presence of electro-surgery.



WARNING Cross-contamination or nosocomial infection risk. Clean and disinfect the monitor on a routine basis according to your facility's protocols and standards or local regulations. Thorough hand-washing before and after contact with patients greatly reduces the risk of cross-contamination and nosocomial infection.



WARNING For patient safety, do not use the monitor or any accessory during MRI scanning. Induced current could cause burns.



WARNING When the monitor is not connected to a secondary alarm system during continuous monitoring, check the monitor regularly to receive patient data, alarms, and alerts.



WARNING Patient safety risk. The EarlySense system is not intended for high-risk patients in coronary or respiratory distress who require continuous monitoring of heart function or CO₂. For these patients, the most reliable method of patient monitoring involves close personal surveillance and/or equipment suited to that type of monitoring.



CAUTION United States Federal law restricts this monitor to sale, distribution, or use by or on the order of a physician or licensed healthcare professional.



CAUTION Electromagnetic interference risk. The monitor complies with applicable domestic and international standards for electromagnetic interference. These standards are intended to minimize medical equipment electromagnetic interference. Although this monitor is not expected to present problems to other compliant equipment or be affected by other compliant devices, interference issues still may occur. As a precaution, avoid using the monitor in close proximity to other equipment. In the event that equipment interference is observed, relocate the equipment as necessary or consult manufacturer's directions for use.



CAUTION Use only a Class I (grounded) AC power supply cord for powering this monitor.



CAUTION Do not use a long press of  to power down the monitor when it is functioning normally. You will lose patient data and configuration settings.



CAUTION Never move the monitor or mobile stand by pulling on any of the cords as this may cause the monitor to tip over or may damage the cord. Never pull on the power cord when removing it from the power outlet. When disconnecting the power cord, always grasp the attachment plug and not the cord. Keep the cord away from liquids, heat, and sharp edges. Replace the power cord if the strain relief or cord insulation is damaged or begins to separate from the attachment plug.



CAUTION Use only the Welch Allyn USB client cable to connect a laptop computer to the USB client port. Any laptop connected to the monitor must be running on a battery, a 60601-1-compliant power supply, or a 60601-1-compliant isolation transformer. While monitoring a patient, you can only charge the laptop battery if it is connected to 60601-1-compliant, isolated AC power.



CAUTION If the touchscreen is not responding properly, refer to the troubleshooting section. If the problem cannot be resolved, discontinue use of the monitor and contact an authorized Welch Allyn service center or qualified service personnel.



CAUTION Verify patient identity on the monitor after manual or barcode entry and before printing or transferring patient records.



CAUTION Keep the monitor outside of MRI suites and any areas marked for high magnetic or electric field strength.

Integrated Wall System warnings and cautions

In addition to the preceding warnings and cautions, consider the following when using the Integrated Wall System.



WARNING Liquids can damage electronics inside the Connex IWS. Prevent liquids from spilling on the wall system.

If liquids are spilled on the wall system:

1. Power down the wall system.
2. Disconnect the power plug.
3. Remove the wall system from the wall.
4. Remove battery pack from the wall system.
5. Dry off excess liquid from the wall system.

Note If liquids possibly entered the wall system, remove the wall system from use until it has been properly dried, inspected, and tested by qualified service personnel.

6. Reinstall battery pack.
7. Mount the wall system on the wall.
8. Power on the wall system and verify that it functions normally before using it.



WARNING The physical assessment instruments (handles) are designed for intermittent use. On-time should not exceed 2 minutes. Allow at least 10 minutes off-time between patients.



CAUTION Welch Allyn is not responsible for the integrity of any wall mounting interface. Welch Allyn recommends that you contact your Biomedical Engineering Department or maintenance service to ensure professional installation, safety, and reliability of any mounting accessory.

Physical design

Vital Signs Monitor 6000 Series

Standard and extended monitors

The monitor is available in two sizes: standard and extended. The primary difference between these models is the number of parameters they support.

Note Your monitor, based on size or configuration, might not contain all parameters or features illustrated in this section.

In a standard monitor, up to two parameter modules are installed on the left side. You can tell which modules are installed based on the connectors visible on the outside of the device. The following image shows a standard monitor with pulse-oximetry and blood-pressure modules.

Standard monitor left side

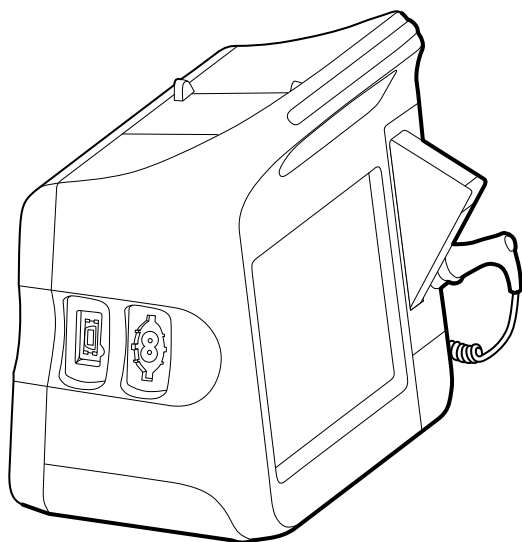

The extended version can have a maximum of three modules (such as CO₂, pulse oximetry, and blood pressure) on the left side.

Extended monitor left side

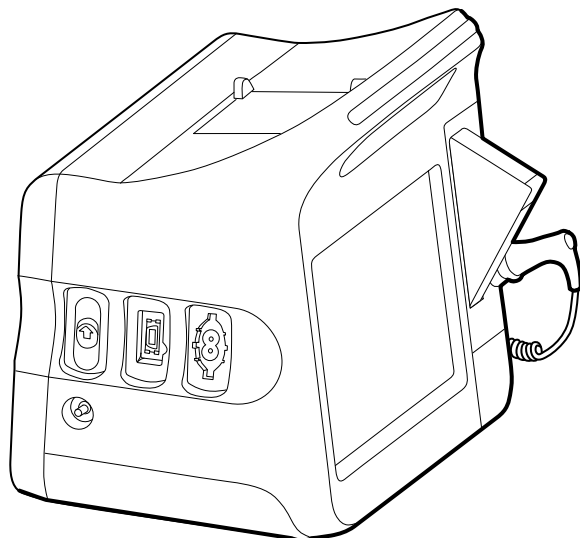

If the extended monitor is configured with EarlySense, it has an additional module on the right side.

Extended monitor right side

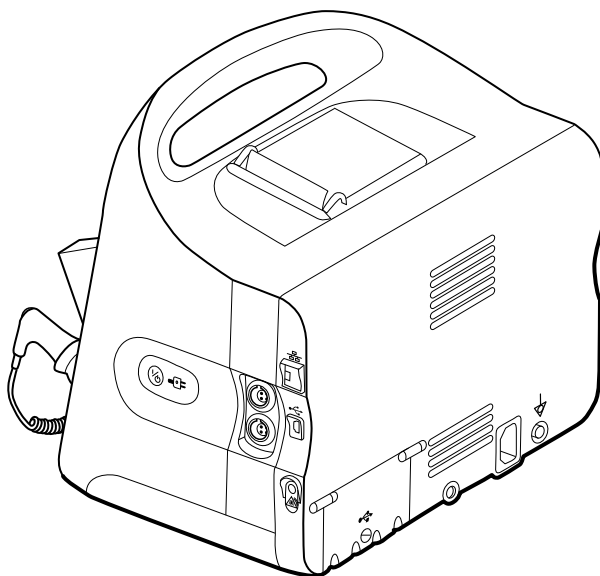

Equipment setup and basic monitor functions are the same for both models, unless otherwise noted in the directions for use.

Controls, indicators, and connectors

The following diagrams show a full-featured monitor. Your monitor, based on size or configuration, might not contain all of these features.

Top-Left-Front view

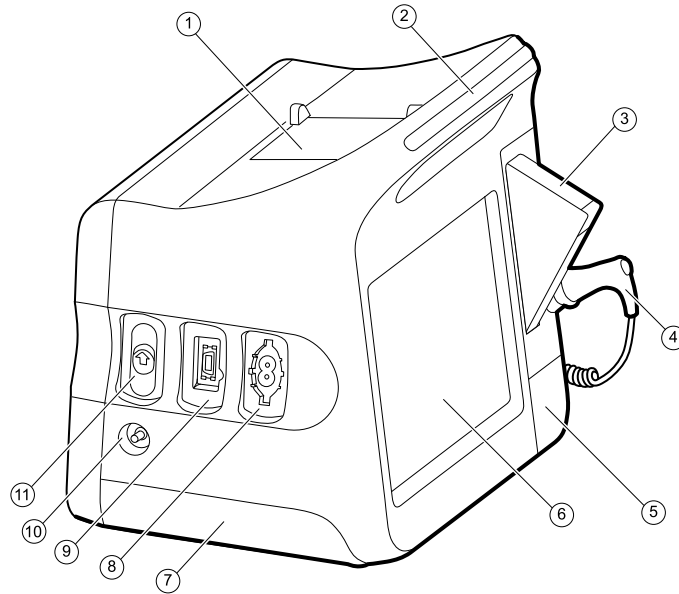

No.	Feature	Description
1	Printer	Printer provides a printout of patient and device information.
2	Light bar	Provides a visual alarm with red and amber LEDs.
3	Thermometry	Temperature probe cover box.
4	Thermometry	Temperature probe.
5	Thermometry (connector behind cover)	Secures the probe connection to the monitor.
6	LCD screen	1024 x 600 pixels color touchscreen provides a graphical user interface.
7	Battery compartment (behind cover)	Houses the lithium-ion battery.
8	Blood pressure	Supports dual-lumen or single-lumen hoses.
9	Pulse oximetry	Nellcor or Masimo rainbow SET module. The Nellcor module measures SpO2 and pulse rate. The Masimo module measures SpO2, pulse rate, SpHb, and RRa.
	Note	SpHb and RRa are optional parameters.
	Note	Monitors configured with RRa cannot be configured with CO2.
10	CO2	CO2 sampling exhaust port.
11	CO2	CO2 sampling input connector (behind cover).

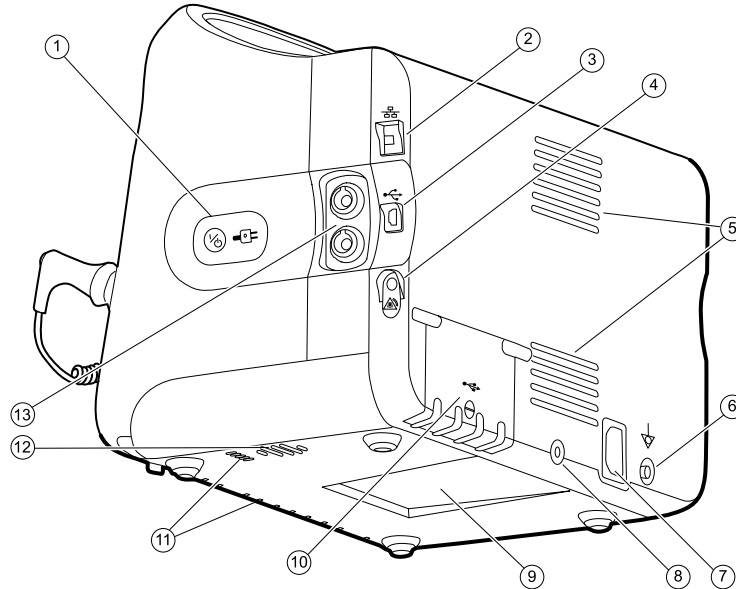
Right-Back-Bottom view

No.	Feature	Description
1	Power switch and LED	Power-on/Display power-saving button. The LED indicates the charging status when the monitor is connected to AC power: <ul style="list-style-type: none"> • Green: The battery is charged. • Amber: The battery is charging.
2	Ethernet RJ-45	Provides a hardwired connection to the computer network.
3	USB client	Provides a connection to an external computer for testing and software upgrades.
4	Nurse call	Provides a connection to the hospital nurse call system. (Not available on the 6300 model.)
5	Fan exhaust	
6	Ground lug (equipotential terminal)	Provided for electrical safety testing and as a means for connection of a potential-equalization conductor.
7	Power connection	Provides an external AC power connection.
8	Mobile stand mounting hardware	Secures the mounting plate to the monitor.
9	Recess for mounting plate	Secures the monitor when the monitor is mounted on the mobile stand or wall.
10	USB connector door	Provides access to host USB connections for optional accessories.
11	Fan intake	

No.	Feature	Description
12	Speaker	Provides tones. A piezo beeper inside the monitor provides backup.
13	Patient movement	The EarlySense module monitors patient movement, respiration (RR), and pulse rate.
	Note	Monitors configured with RRa and CO2 cannot be configured with EarlySense.

Integrated Wall System

Controls, indicators, and connectors

Note Your model might not contain all of these features.

Front view

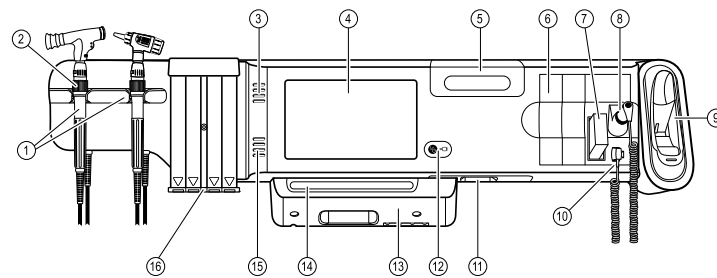

No.	Feature	Description
1	Physical assessment instruments - Handles and handle cradles	Handles will accept any 3.5V Welch Allyn instrument head. The handle cradles support using one handle at a time. A handle turns on automatically when you remove it from a cradle and turns off when you return it.
2	Rheostat	Located on each handle. Turn clockwise to increase light output; turn counterclockwise to decrease light output.
3	Exhaust vents	Exhaust vents cool the monitor.
4	LCD screen	1024 x 600 color touchscreen provides a graphical user interface.
5	Storage compartment	Provides covered storage for additional probe covers and other small accessories.
6	Expansion slots	Provide space to add modules.
7	SureTemp® Plus thermometer probe covers	Support temperature measurements from oral, axillary, and rectal sites.
8	SureTemp® Plus thermometer probe	Supports temperature measurements from oral, axillary, and rectal sites.

No.	Feature	Description
9	Braun ThermoScan® PRO 4000 thermometer and dock	Support temperature measurements from the ear. Dock charges the thermometer battery.
10	SureTemp® Plus thermometer connector	Secures the probe connection to the wall system.
11	Blood pressure and pulse oximetry	See front underside view for more detail.
12	Power switch and LED	Power-on/Standby switch. The LED indicates the charging status when connected to AC power: <ul style="list-style-type: none"> • Green: The battery is charged. • Amber: The battery is charging.
13	USB/Comms cover	Houses light bar. Provides access to host USB connections for optional accessories and some routing for cords and cables.
14	Light bar	Provides a visual alarm with red and amber LEDs.
15	Speaker	Provides tones. A piezo beeper inside the monitor provides backup.
16	Specula dispenser	Dispenses KleenSpec® disposable specula in pediatric (2.75 mm) and adult (4.25 mm) sizes.

Front underside views

(Left: USB/Comms cover attached; Right: USB/Comms cover removed)

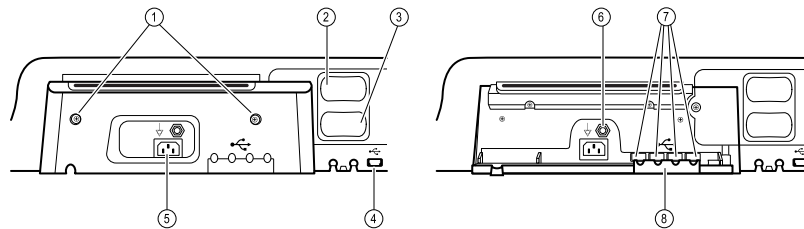

1	Retention screws	Supports removing and attaching USB/Comms cover.
2	Blood pressure	Self-contained module for easy replacement. Supports dual-lumen or single-lumen hoses.
3	Pulse oximetry	Optional Nellcor (SpO2) or Masimo Rainbow SET (SpO2 or combined SpO2/SpHb) in a self-contained module for easy replacement.
4	USB-to-computer connector	Provides a connection to an external computer for testing, data transfer, and software upgrades.
5	Power connection	Provides an external AC power connection.
6	Ground lug (equipotential terminal)	Supports electrical safety testing; terminal for connecting a potential equalization conductor.

No.	Feature	Description
7	USB connectors	Provides access to host USB connections for optional accessories.
8	USB cable retainer	Reduces strain on USB cables and connectors; helps prevent cables from disconnecting.

Back view

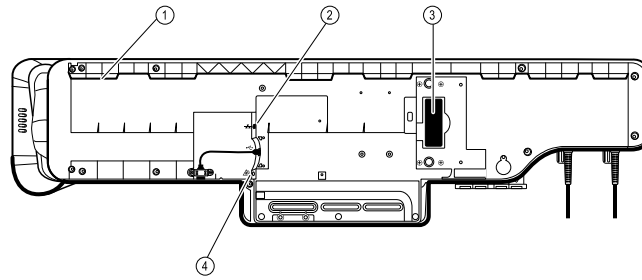

1	Recess for mounting bracket	Secures the monitor when mounted on the wall.
2	Ethernet RJ-45	Provides a hardwired connection to the computer network.
3	Li-ion battery	Provides backup power to wall system.
4	Nurse call	Provides a connection to the hospital nurse call system.

Accessory bin

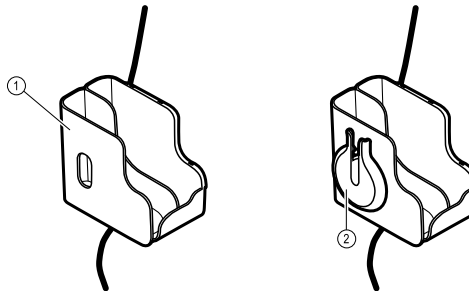

1	Accessory bin	Stores accessories and organizes cables.
2	SpO2 holder	Provides location to wrap SpO2 cable and attach SpO2 finger clip.

Mounting materials

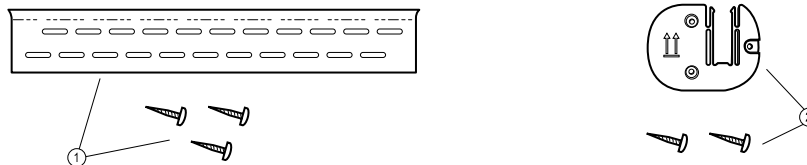

1	Wall mounting rail bracket and hardware	Secures the wall system to the wall.
---	---	--------------------------------------

No.	Feature	Description
2	Accessory bin mounting bracket and hardware	Secures accessory bin to the wall and provides routing and strain relief for power cord.

Setup

Vital Signs Monitor 6000 Series

Supplies and accessories

For a list of all approved supplies and accessories, see *Approved accessories* in the Appendix.

Insert the battery

This procedure applies to first-time setup of the monitor.



WARNING Risk of fire, explosion, and burns. Do not short-circuit, crush, incinerate, or disassemble the battery pack.

1. Turn the monitor upside down to access the battery cover.
2. Locate the battery cover, indicated by .
3. Insert a coin into the slot and push to open. Choose a coin that fits comfortably into the slot.

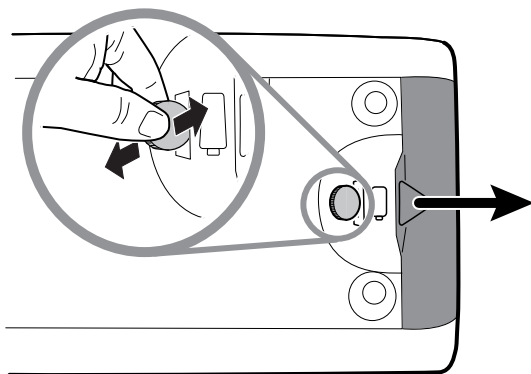

4. Slide in the battery.

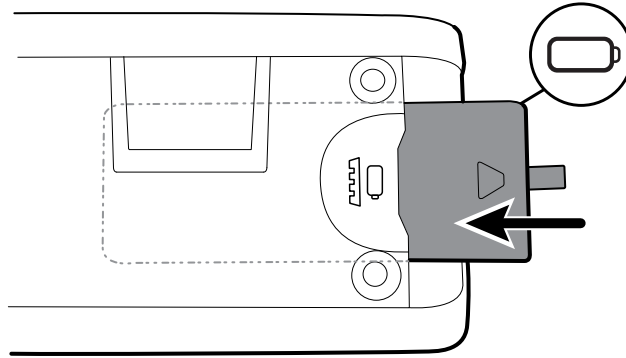

Note Do not remove the tab label from the battery. This tab helps you remove the battery from the compartment when you need to replace it.

5. Replace the battery cover by inserting one end into the notched access and then pressing firmly on the opposite end.

Note New batteries are only 30 percent charged. Therefore, connect the monitor to AC power immediately after inserting a new battery.

Mount the monitor

You can install the monitor on a mobile stand or on an interior wall equipped with a Welch Allyn-approved wall-mount fixture.

Check the mounting bracket

Before you mount the monitor, make sure the stand or wall-mount fixture has the mounting bracket designed for your monitor. Monitors with a standard housing require a small bracket. Monitors with an extended housing require a large bracket.

Small bracket for standard housing

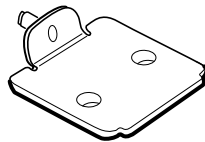

Large bracket for extended housing

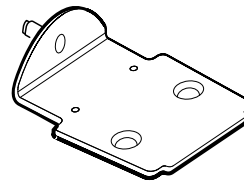

Note If your monitor has an extended housing but the small bracket is installed on your stand or wall-mount fixture, you must replace the small bracket with the large bracket. Follow the steps presented in the *Mounting Bracket Replacement Install Guide* shipped with the large bracket, and then proceed to mount the monitor.

Mount the monitor on a stand

1. Align the monitor on the mounting bracket in the center of the stand tray. Slide the monitor into place, catching the bracket in the guides on the bottom of the monitor.
2. Ensure that the monitor is properly seated on the bracket. If you can raise either side of the monitor off the stand, it is not seated properly. Repeat step 1 until the monitor is mounted correctly.
3. Tighten the screw on the bracket into the screw hole on the back of the monitor.

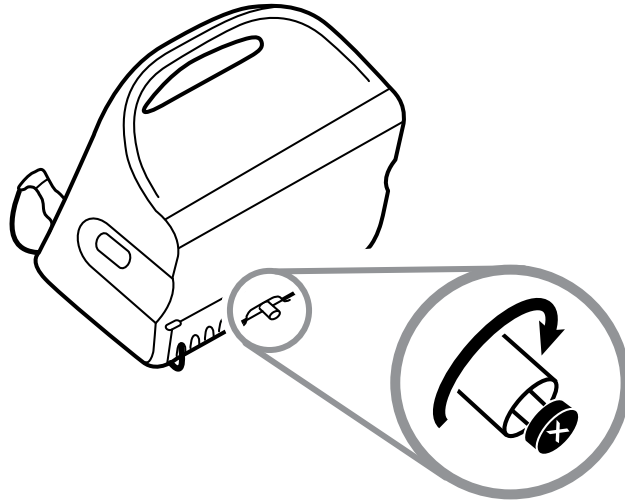

Mount the monitor on the wall

For mounting instructions, see the wall mount manufacturer's directions for use.

Attach the probe well

1. Align the probe well with the tabs facing up and down and insert the probe well into the temperature module.

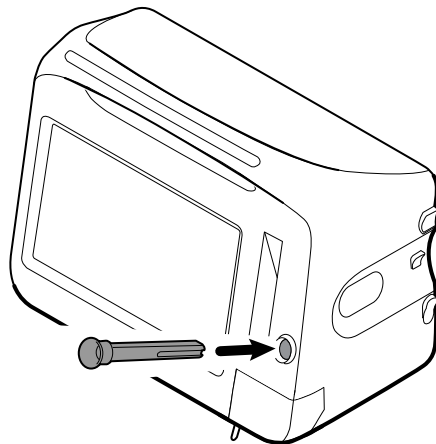

The probe well snaps into place when it is fully seated.

2. Insert the temperature probe into the probe well.

Attach the temperature probe



CAUTION The temperature module only operates with the probe well properly in place.

1. Remove the cover of the temperature module by pressing the tab on the bottom and sliding the cover to the right. The cover is located at the bottom-right of the monitor, below the probe well.

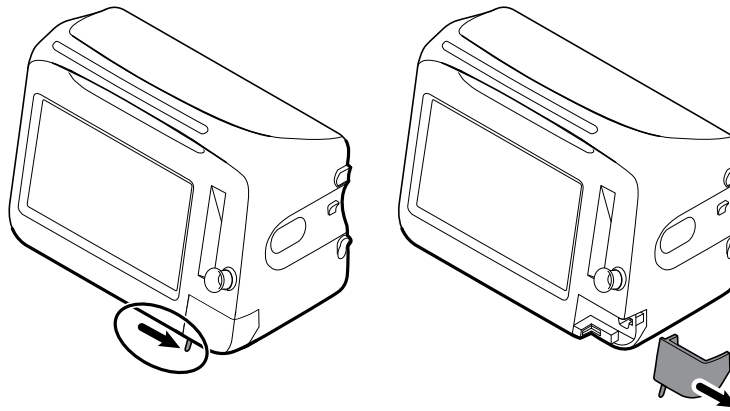

2. Hold the temperature probe cable connector with the spring tab on the right and insert it into the probe port of the temperature module.

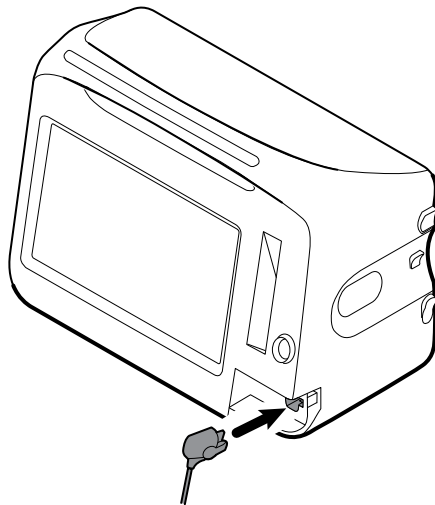

3. Push it into place until it clicks.
4. Reattach the cover. Use the alignment tab and slide the cover to the left to click it back into place.

Remove the temperature probe and well

Follow these steps to disconnect the probe cable and remove the probe well.

1. Remove the cover of the temperature module by pressing the tab on the bottom and sliding the cover to the right. The cover is located at the bottom-right of the monitor, below the probe well.

2. Depress the spring tab on the temperature probe cable connector and withdraw it from the probe port.
3. Reattach the cover. Use the alignment tab and slide the cover to the left to click it back into place.

Grasp the probe well and pull it up to remove it from the monitor.

Connect the NIBP hose

1. Place your thumb and forefinger on the hose connector and squeeze the side tabs.
2. Align the hose connector with the hose connector port on the side of the monitor.

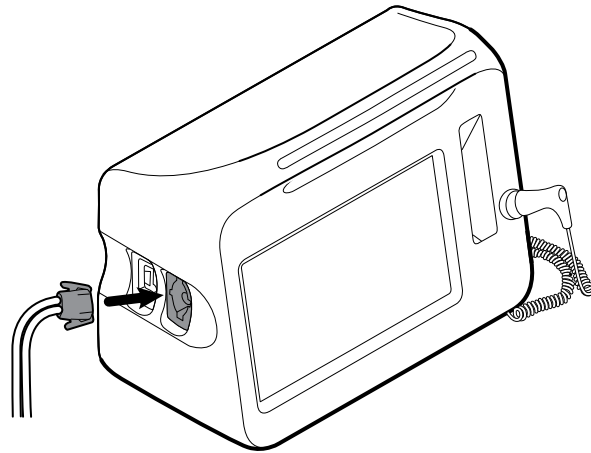

3. Insert the hose connector, pressing firmly until it clicks into place.

Disconnect the NIBP hose

1. Place your thumb and forefinger on the hose connector.

Note Always grasp the hose by the connector. Do not pull on the hose itself.

2. Squeeze the side tabs until the connector releases.
3. Pull the connector away from the connector port.

Connect the SpO2 cable or the SpO2/RRa dual cable



WARNING Patient injury risk. Do not use a damaged sensor or pulse oximetry cable or a sensor with exposed electrical or optical components.

Follow these steps to connect the SpO2 cable or the SpO2/RRa dual cable to the SpO2 port on the monitor. The location of the port on your monitor might differ from that shown in the images below.

Note For monitors configured with SpHb, the sensor used to monitor SpHb also measures SpO2.

Connect the SpO2 cable

1. Place your thumb and forefinger on the cable connector and squeeze the side tabs.

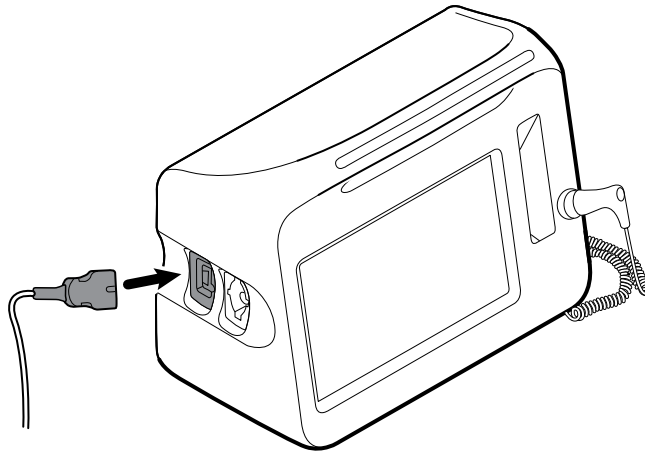

2. Align the cable connector with the cable connector port.
3. Insert the cable connector, pressing firmly until it clicks into place.

Connect the SpO2/RRa dual cable

Note Monitors configured to measure acoustic respiration (RRa) require a dual cable as shown below. The dual cable has two ports, one for the SpO2 cable and the other for the RRa cable.

1. Connect the dual cable to the device as shown in the preceding steps. (The connector is the same as for the standard SpO2 cable.)

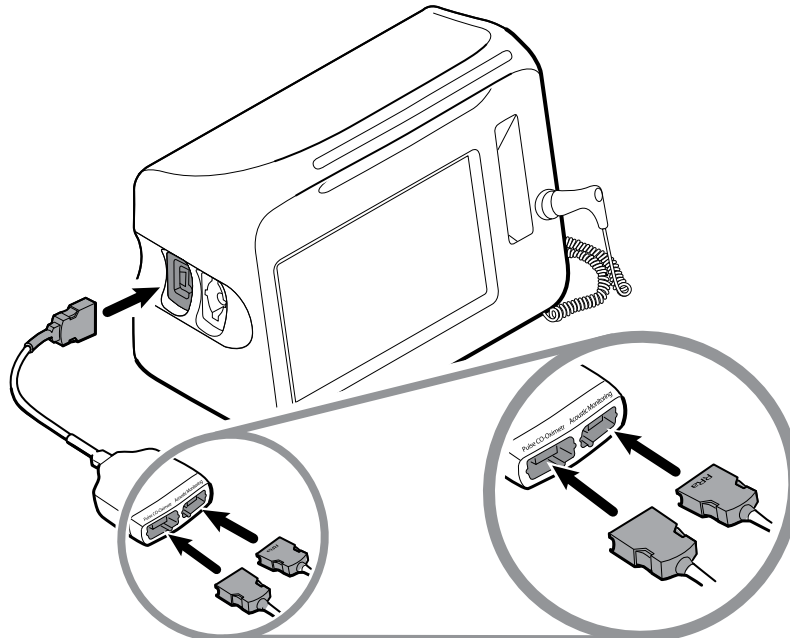

2. Connect the SpO2 cable to the Pulse CO-Oximetry port (the larger of the two ports with the red background).
3. Attach the RRa patient cable to the Acoustic Monitoring port (the smaller of the two ports with no colored background). See the dual cable manufacturer's directions for use for more information.

Note Labels appear on both the top and bottom of the dual connector as well as on the patient cables to help ensure proper connection of the patient cables to the dual cable.

Note Typically, a clinician will connect the single-use RRa sensor to the RRa patient cable at the start of acoustic respiration monitoring. See the sensor manufacturer's directions for use for more information. Also see the Acoustic Respiration rate (RRa) section of this directions for use.

Disconnect the SpO2 cable or the SpO2/RRa dual cable

1. Place your thumb and forefinger on the cable connector.

Note Always grasp the cable by the connector. Do not pull on the cable itself.

2. Squeeze the side tabs until the connector releases.
3. Pull the connector away from the connector port.

Connect the patient movement cable

1. Align the EarlySense cable connector with one of the EarlySense ports on the right side of the monitor.

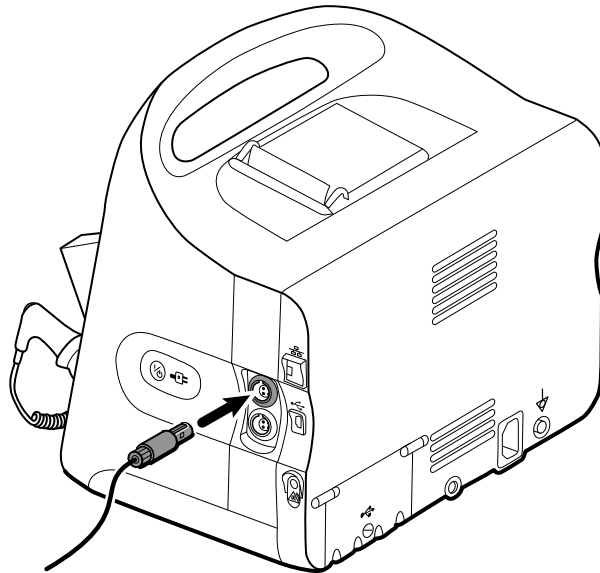

2. Insert the cable connector until it clicks into place. Also check the stress relief connector on the cable to ensure that both parts of the cable are tightly connected.
3. When you are ready to monitor a patient, position the bed sensor (sensing unit) as follows:
 - horizontally under the patient's mattress
 - the top surface of the sensing unit facing the mattress
 - the sensing unit under the patient's chest area
 - the sensing unit cable extending toward the head of the bed

Note Typically, a clinician will connect the bed sensor and cable at the start of patient movement monitoring. See the Patient movement section of this directions for use for more information.

Disconnect the patient movement sensor and cable

To disconnect the EarlySense bed sensor, pull the sensor cable connector out of the cable connector port on the device.

Attach a USB accessory



CAUTION Accessories attached to this monitor must run on battery power. Do not use any accessory's external power supply when it is attached to the monitor.

1. On the rear of the monitor, loosen the screw on the USB door and open it.

Note

On some monitor stands, the monitor mounting bracket partially overlaps the USB door. If you observe this overlap, loosen the screw on the monitor mounting bracket and shift the monitor forward just enough on the bracket to open the USB door, then slide the monitor back on the mounting bracket.

2. Attach each accessory's USB cable into an unused USB port on the monitor. See the accessory's directions for use for any special instructions.



CAUTION Connect cables in a manner that minimizes entangling.

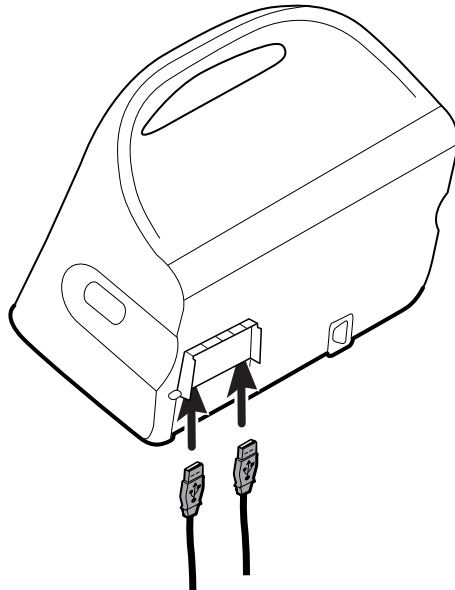

3. Close the door and tighten the screw.

Note If you loosened the monitor mounting bracket in order to open the USB door, shift the monitor forward on the bracket as you did in step 1, close the door, and then slide the monitor back into its mounted position. Ensure that the monitor is seated firmly on the bracket, then tighten the screw on the bracket into the screw hole on the back of the monitor. (See "Mount the monitor on a stand" in this section for more detail.)

Note Some accessories require a license to enable them for use. These accessories are packaged with an authorization code and instructions for activating the license using the Welch Allyn Service Tool. For more information, refer to the instructions and the service tool installation guide.

Detach a USB accessory

1. On the rear of the monitor, loosen the screw on the USB door and open it.
2. Detach the accessory's USB cable from USB port on the monitor.
3. Close the door and tighten the screw.

Insert a new roll of paper

The printer is located on the top of the monitor. Follow these steps to insert the roll of printer paper:

1. Grasp the two tabs on the printer door and pull up to open.
2. Insert a new roll of paper.

Note The paper roll must be installed so that it unwinds from the bottom of the roll, as illustrated. If the paper roll is not installed correctly, the printer will not print properly.

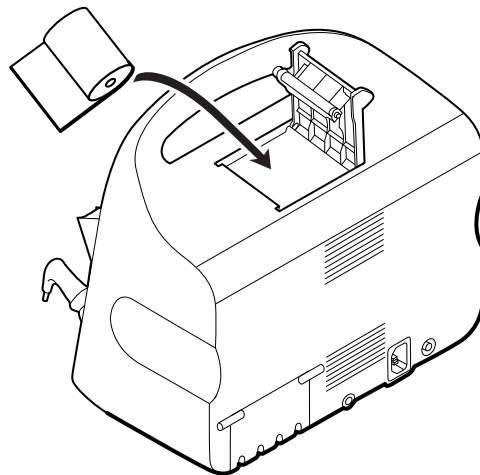

3. Advance the end of the roll past the roller so that it extends past the printer door, as shown.

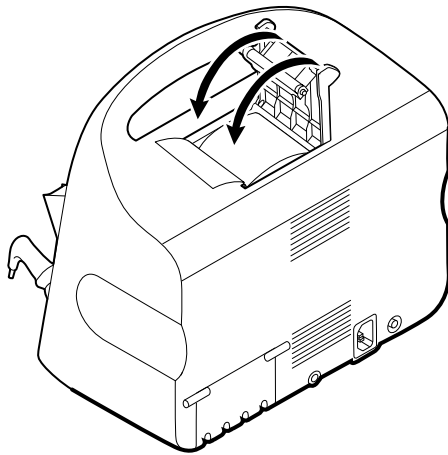

4. With one hand, pull lightly on the paper to take up any slack. With the other hand, close the printer door by pushing it down and into place until it clicks.

Be certain that the paper does not catch in the printer door.

Connect AC power

You can use the monitor with AC or battery power (after fully charging the battery).



WARNING Shock hazard. Inspect the AC cord for exposed copper before touching the cord.



CAUTION During continuous monitoring, keep the monitor connected to AC power at all times. If only battery power is available, you must remain in the room with any patient whose vital signs are being monitored continuously. Actively monitor both patient and battery status to ensure patient safety.

1. Insert the power cord into the AC power connector port on the back of the monitor.

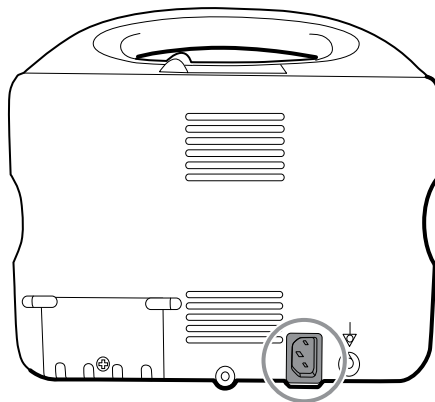

2. Insert the power plug into an electrical outlet to power the monitor and to charge the battery.

Disconnect AC power

Carefully grasp the power plug and disconnect it from the power outlet. To avoid damaging the power cord, do not pull on the cord itself.

Integrated Wall System



CAUTION Welch Allyn is not responsible for the integrity of any wall mounting interface. Welch Allyn recommends that you contact your Biomedical Engineering Department or maintenance service to ensure professional installation, safety, and reliability of any mounting accessory.

Supplies and accessories

For a list of all approved supplies and accessories, see *Approved Accessories* in the Appendices.

Unpack the wall system

This procedure applies to first-time setup of the wall system.



CAUTION You must follow these instructions exactly to ensure safety and ease of assembly.



CAUTION Do not remove any packing materials around the wall system until the instructions tell you to do so.

1. Lift the wall system out of the box by the cardboard handles.

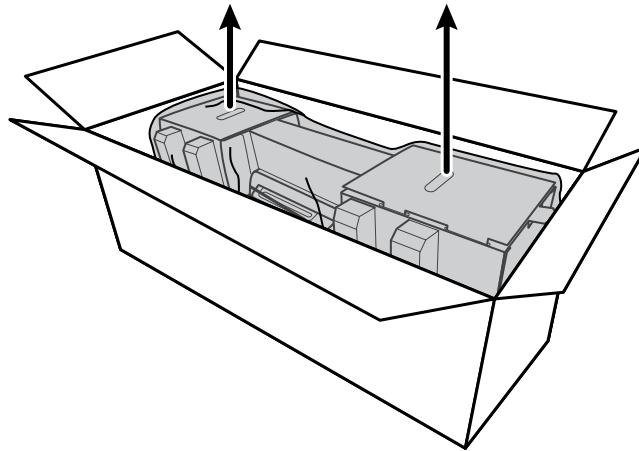

2. With the wall system still in its packing material, place it onto a table or flat work surface and remove it from the plastic bag.

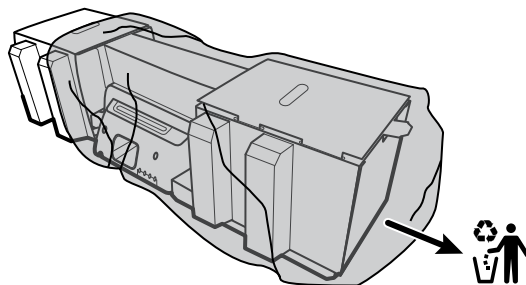

3. Turn the wall system over so that back of the wall system faces up.

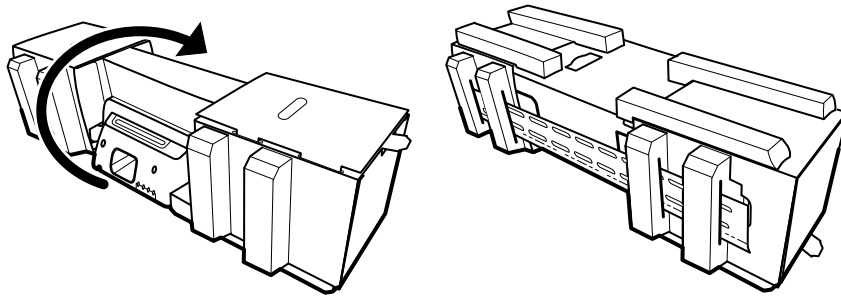

Insert the battery

This procedure applies to first-time setup of the wall system. Therefore, the wall system is assumed to be shut down.



WARNING Risk of fire, explosion, and burns. Do not short-circuit, crush, incinerate, or disassemble the battery pack.

1. Locate the battery compartment, indicated by .

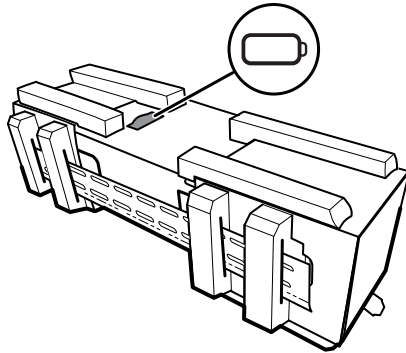

2. Insert the battery. (The battery is in a pink anti-static bag in the accessory box.)

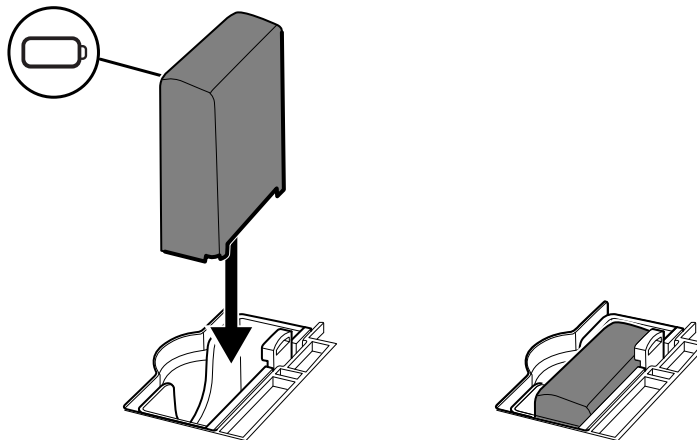

Prepare for mounting

1. Slide the mounting rail bracket out of the packing material and put it aside. Do not discard. Then flip the wall system onto its back.

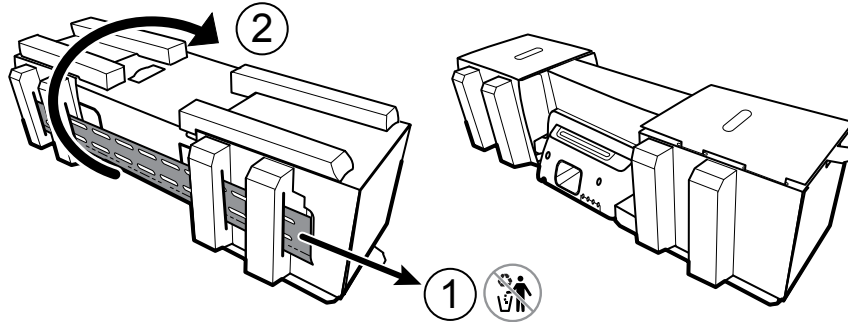

2. Remove the cardboard end caps and all foam as shown and put aside for recycling.

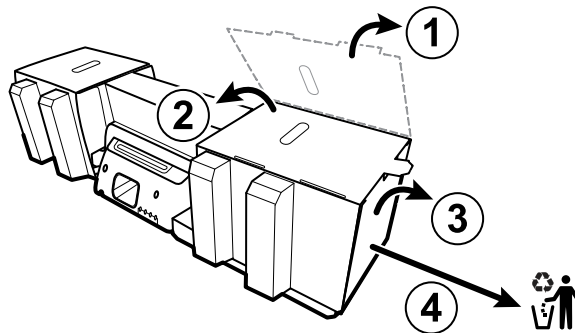

CAUTION Do not remove the cardboard securing the handles on the left side of the wall system at this time. The cardboard prevents damage to those instruments during the mounting process.

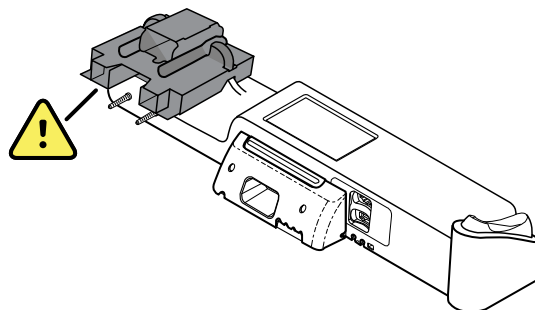

Mounting hardware inventory

Use these items to mount the wall system.

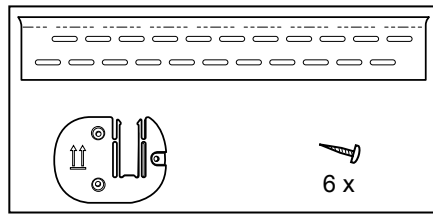

- Mounting rail bracket
- Accessory bin bracket
- Screws

Tools list

Use these tools to mount the wall system.

- #2 Phillips screwdriver
- level
- tape measure
- stud finder
- drill
- 1/8-inch (3.17 mm) diameter drill bit

Mounting location

Before mounting the wall system, consider the following recommendations to determine the best mounting location:

- Mount the wall system to studs.
- Mount the wall system within reach of the AC power outlet. The power cord is 8 ft. (2.44 m) long.
- Avoid brightly lit areas.
- Blood pressure tubing is 8 ft. (2.44 m) long.
- Position the wall system so that all instruments are accessible and in a location that allows for ergonomic examinations.

Sample room layout

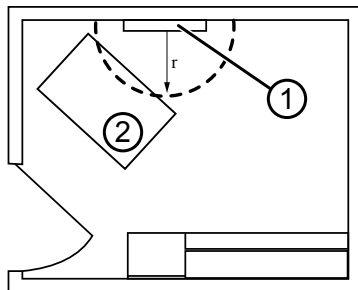

1. Connex Integrated Wall System
2. Examination table

Mount the wall system

1. On the selected wall, find and mark the studs, and choose the system height and corresponding height for the mounting rail bracket.

Recommendation: Place the mounting rail bracket 63 in. (1.6 m) from the floor, which places screen center height at approximately 63 in. (1.6 m) from the floor.



CAUTION This drawing shows the physical relationships of the mounting brackets to each other and to the wall system **after** you complete the mounting instructions. Do not place the wall system on the wall until you have completed all preliminary steps.

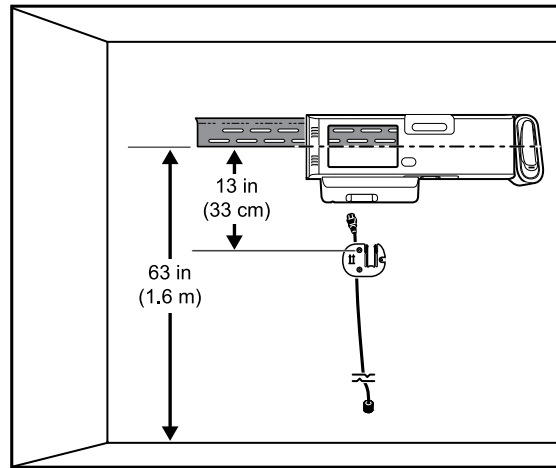

2. Affix the mounting rail bracket to three studs at the selected height using the available screws (anchors are provided for additional support).



CAUTION Ensure that the upper "lip" of the bracket sticks out from the wall and that the bracket is level.

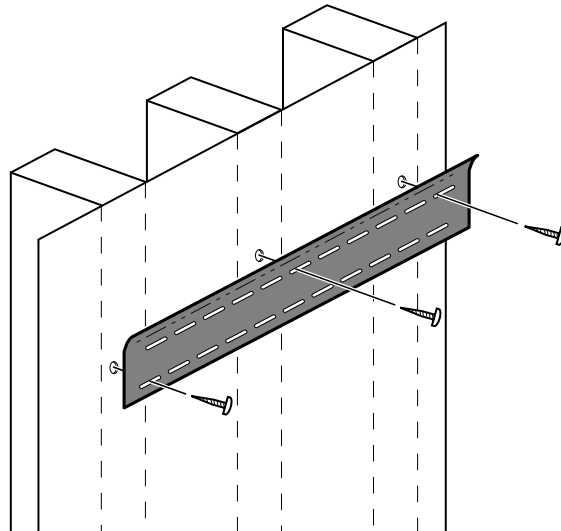

3. Route the power cord through the channel in the back of the accessory bin bracket, then mount the bracket on the center stud at least 13 in. (33 cm) below the mounting rail bracket.

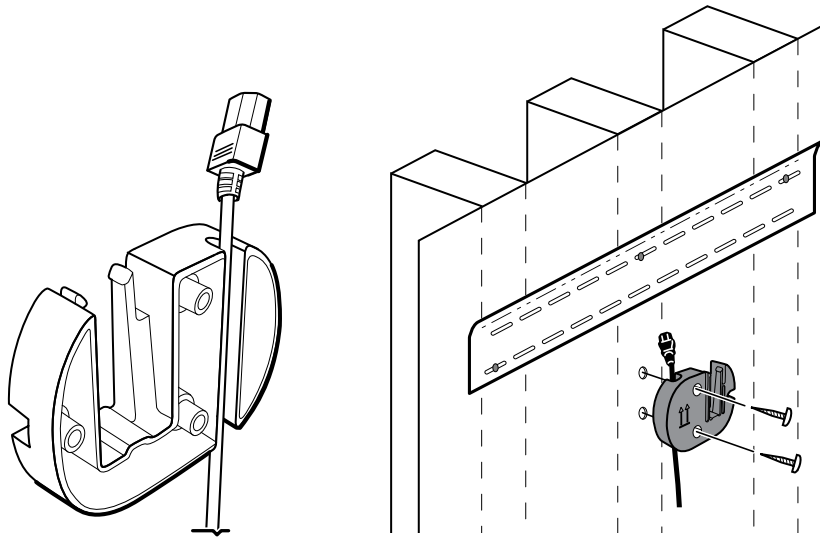

4. Before mounting the wall system, remove the cover by loosening the captive retention screws.

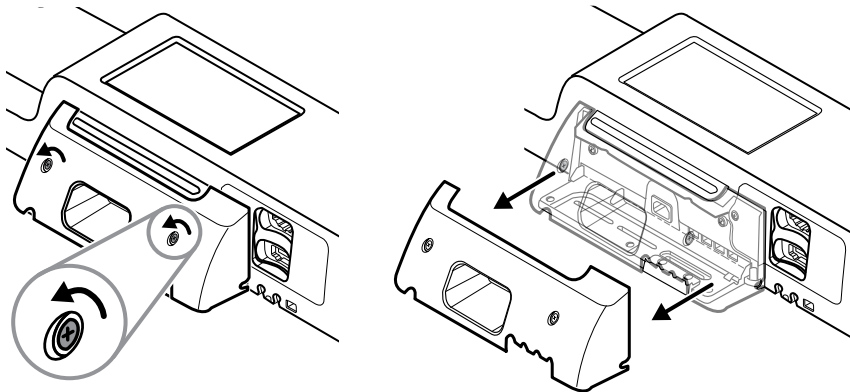

5. Hang wall system on the mounting rail bracket.



WARNING Ensure that the ribs on the back of the wall system fully engage the mounting rail bracket. The wall system should be level and flush to the wall.

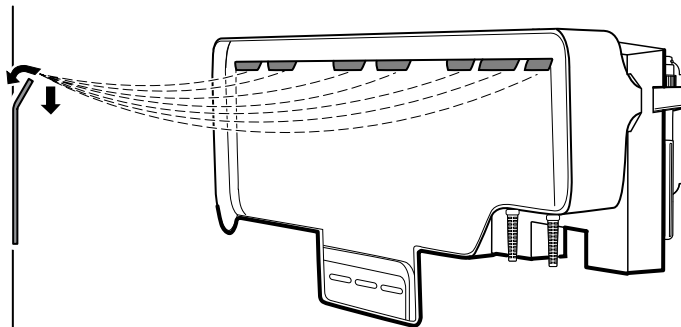

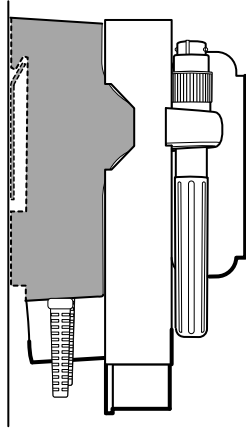

6. Select one of the three available slots at the bottom of the unit that overlaps a stud, and secure the unit to the stud with the remaining screw.



WARNING Failure to install this security screw may result in personal injury and equipment damage.

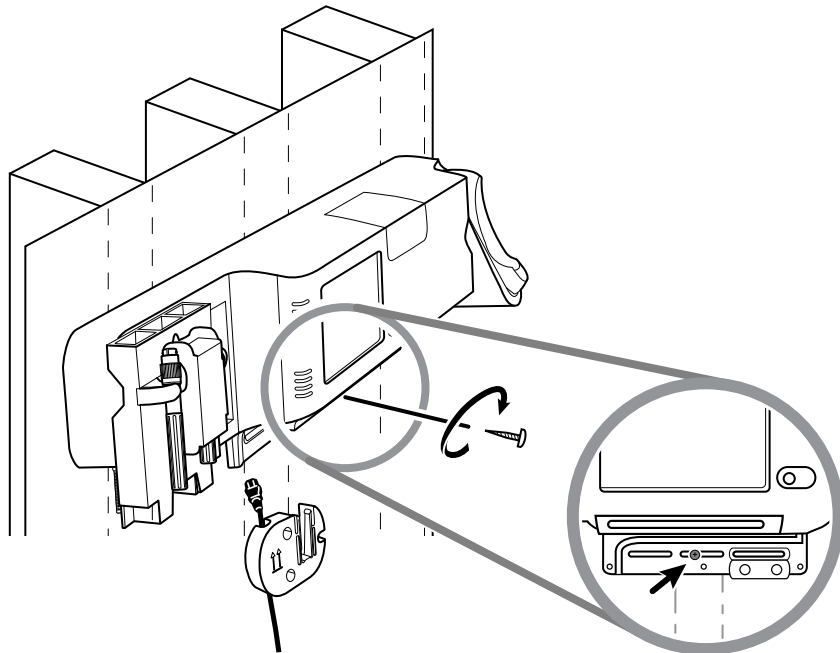

7. If the wall unit is configured for SpO2 or SpHb, connect the sensor cable and route it through the channel above the security screw you just installed.

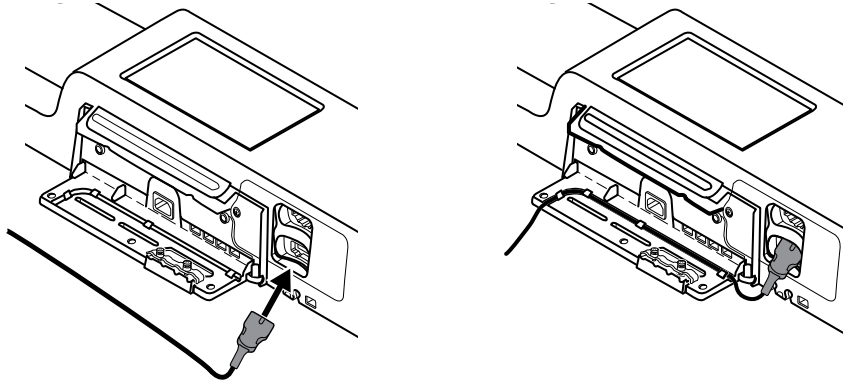

8. Re-attach the cover.
 - a. Thread the sensor cable through the cutouts on the top right and bottom left of the cover.

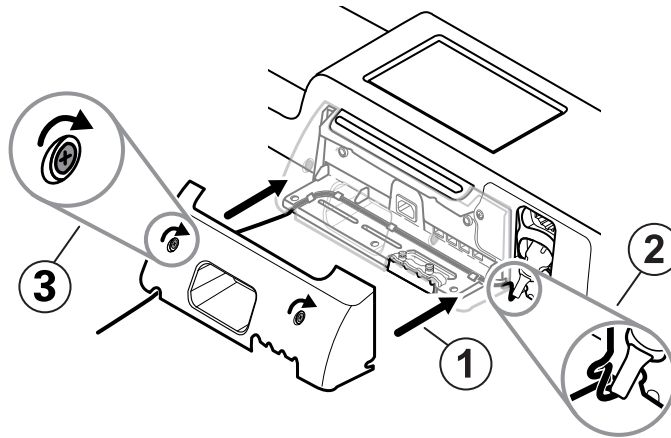

- b. Tighten the two retention screws.
9. Attach the system power cord to the wall unit. Do not plug the cord into an outlet at this time.

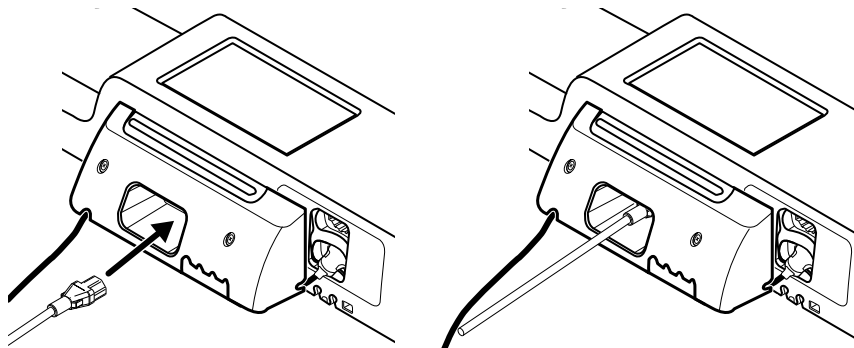

Mount the accessory bin

1. Mount the accessory bin on the accessory bin bracket, then loosely wrap the excess power cord around the accessory bin bracket.

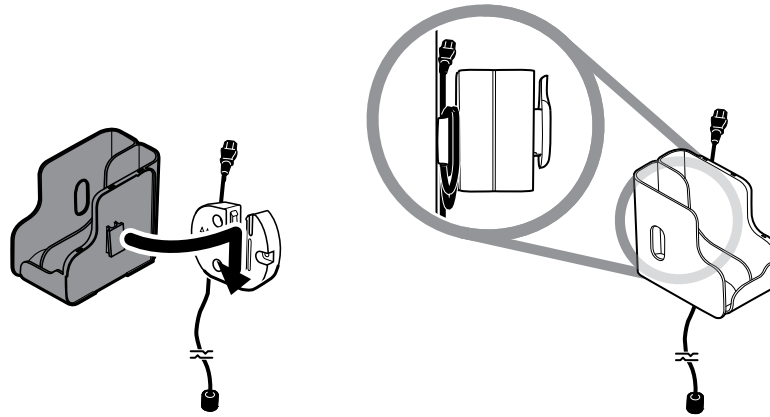

2. If your wall system is configured for SpO₂ (or SpHb), attach the spool to the accessory bin by sliding the spool onto the retention clip.

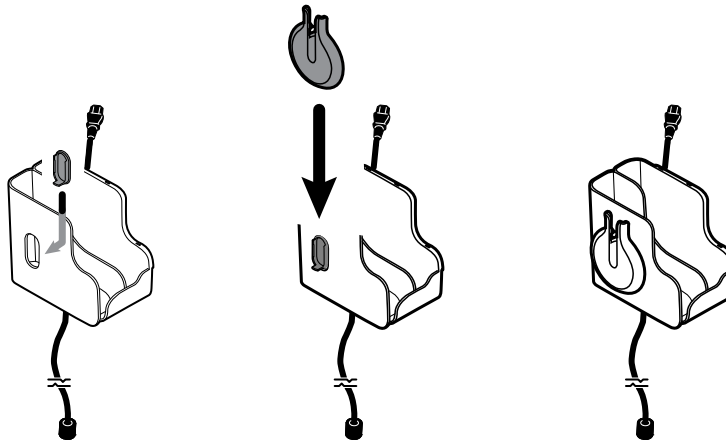

3. Properly orient and insert the sensor cable into the patient cable connector. (You just connected the opposite end of the sensor cable to the wall system.) Ensure the sensor cable is inserted completely, then close the protective cover. (See the sensor manufacturer's directions for use.)
4. Wrap the excess patient cable around the spool, and place the finger clip in the holder.

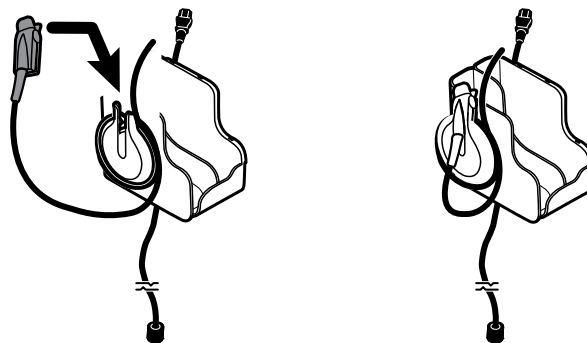

Connect the blood pressure (NIBP) hose

1. Align the hose connector with the hose connector port on the bottom of the monitor.

2. Insert the hose connector, pressing firmly until it clicks into place.

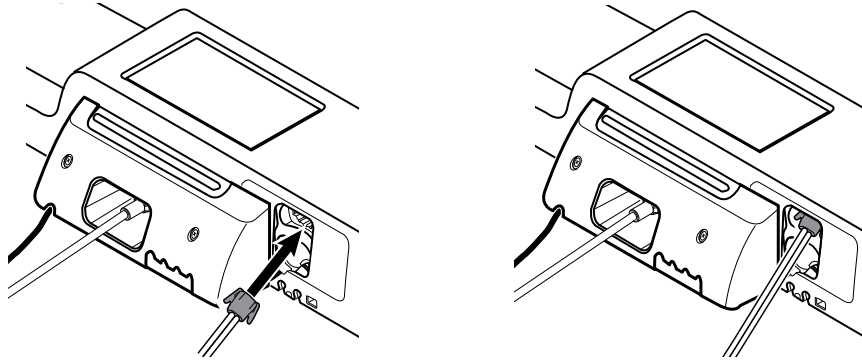

3. Attach a blood pressure cuff to the tubing (see the cuff manufacturer's directions for use), then store the cuff in the accessory bin.

Set up the physical assessment instrument handles and specula dispenser

1. Attach the specula dispenser. Ensure that the keyhole locking slots on the back of the dispenser engage the locking screws on the wall system, then push down firmly.

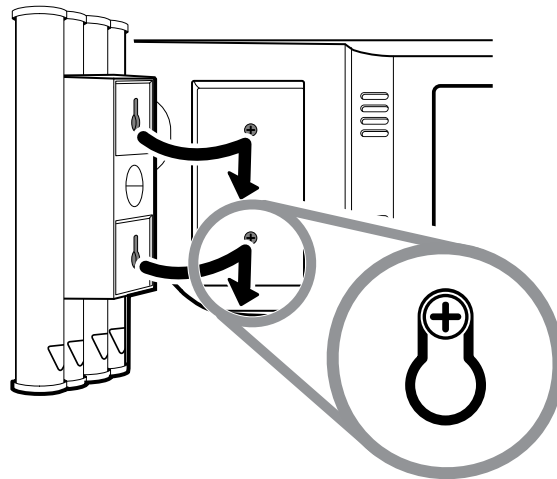

2. Remove cardboard securing instrument handles.

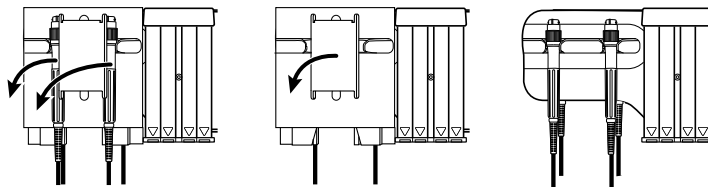

3. Attach Welch Allyn 3.5V instrument heads of your choice to the handles. See the directions for use for each instrument head.

Set up the SureTemp® Plus thermometer

If your wall system is configured for a SureTemp Plus thermometer, follow these setup instructions.

1. Align the probe well with the tabs facing up and down and insert the probe well into the temperature module.

The probe well snaps into place when it is fully seated.

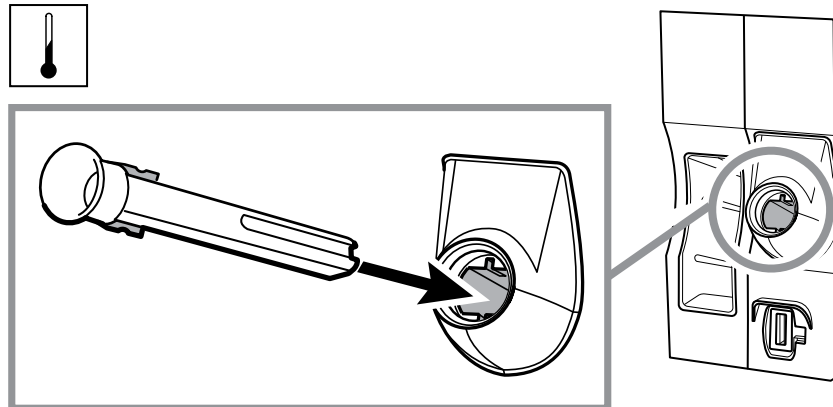

2. Hold the temperature probe cable connector with the spring tab on the right and insert it into the probe port of the temperature module. Push it into place until it clicks.
3. Insert the temperature probe into the probe well.
4. Open a box of probe covers and place it in the probe cover box holder.

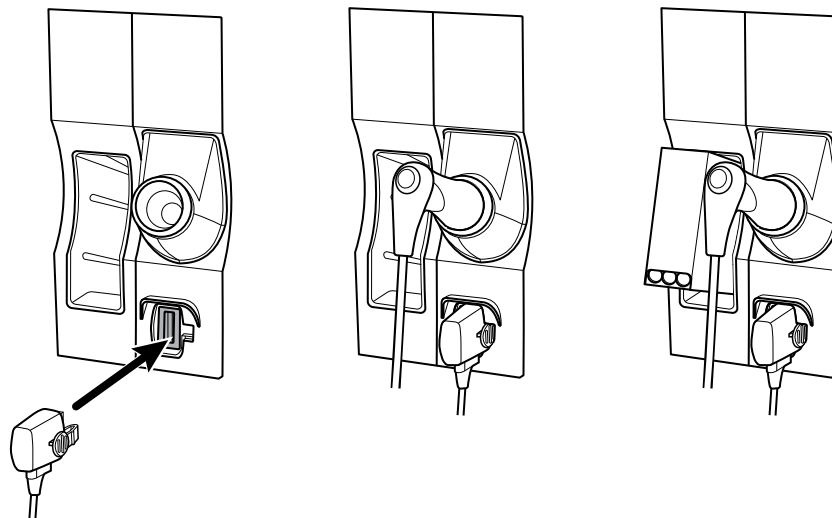

Note

Spare boxes of probe covers can be stored in the compartment on the top of the wall system.

Set up the Braun ThermoScan® PRO 4000 thermometer

If your system is configured for the Braun ThermoScan thermometer, follow these setup instructions.

1. Remove the thermometer from the package and discard the protective casing. Then open a box of probe covers and place it in the dock.

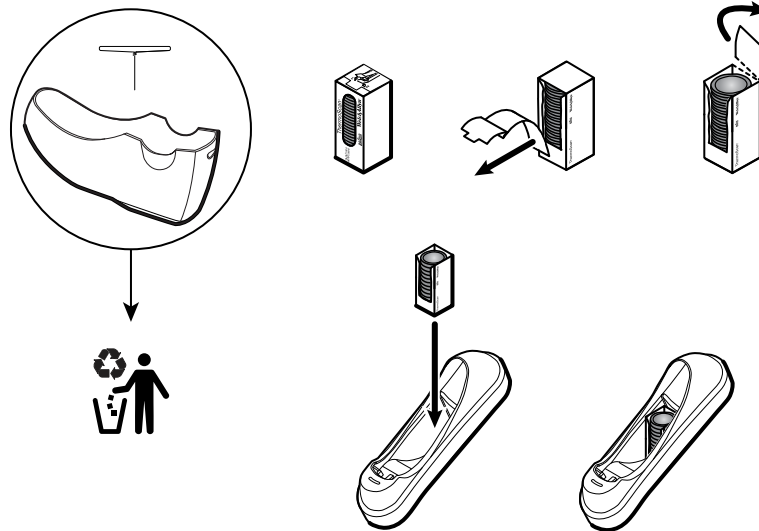

2. Remove the thermometer cover, insert the battery, replace the thermometer cover, then place the thermometer in the dock.

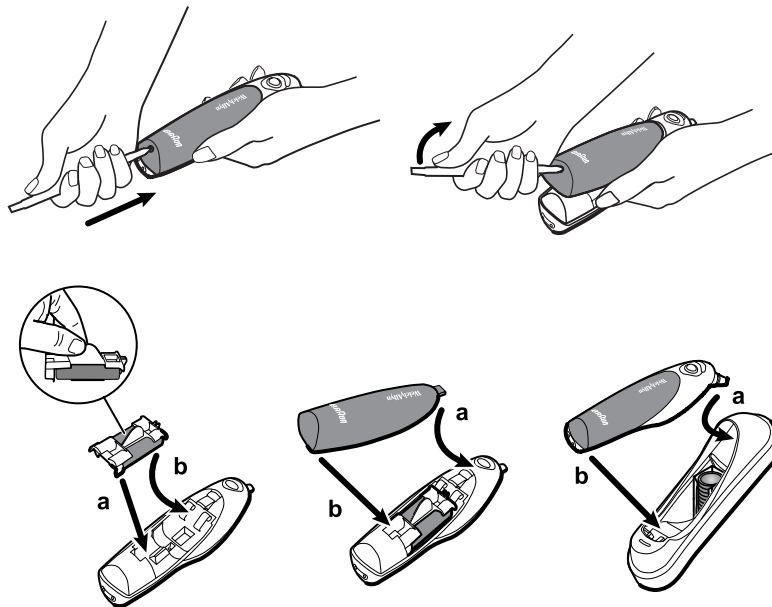

Connect AC power

The wall system uses both battery and AC power. After completing all other setup activities, you can apply power to the wall system.

1. Insert the power plug into an outlet to power the monitor and to charge the battery.

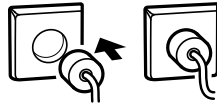

Note New batteries are only 30 percent charged. You must plug the wall system into AC power to fully charge the battery. Do not plug in the power cord until completing all preliminary steps.

2. Proceed to Startup.

Attach an accessory

1. Shut down the wall system and detach the power cord. Then remove the cover from the wall system by loosening the captive retention screws.
2. Loosen the two screws on the cable retention clamp and remove it. Then connect the USB cable(s) to an available connector and thread the cable(s) through the cable guide(s).

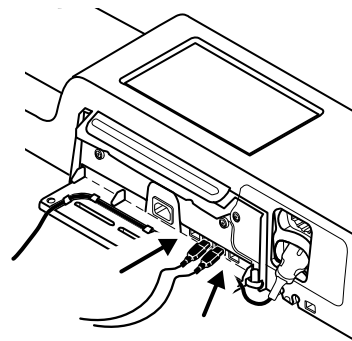
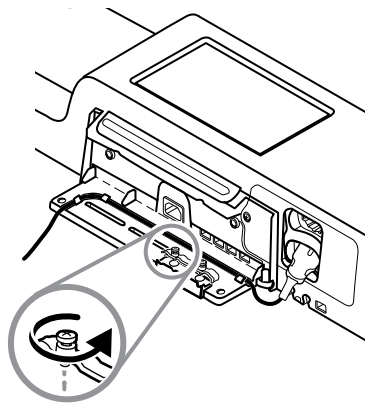

3. Replace the cable retention clamp and tighten the two screws.

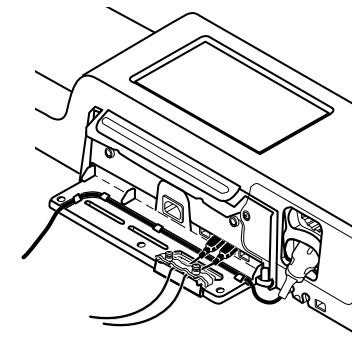
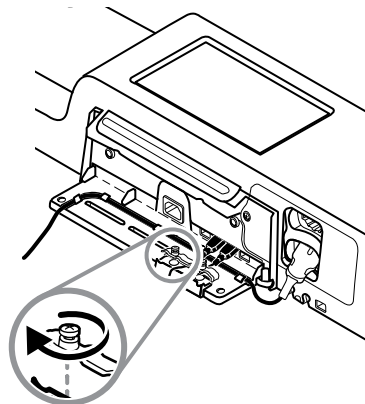

4. Re-attach the cover.
 - a. Thread the SpO2 (or SpHb) cable through the cutouts on the top right and bottom left of the cover.

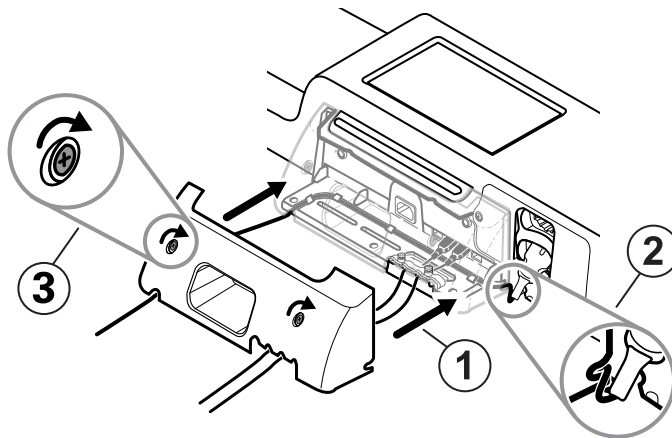

- b. Tighten the two retention screws.
5. Re-attach the system power cord and power up the wall system.

Note Some accessories require a license to enable them for use. These accessories are packaged with an authorization code and instructions for activating the license using the Welch Allyn Service Tool. For more information, refer to the instructions and the service tool installation guide.

Startup

Power

The device operates in one of two power states:

- Device powered on. The device is operating on battery power or AC power. You can utilize the device's features, and the display is active.
- Sleep (Display power-saving) mode. The device is operating on battery or AC power, but the display is off to conserve power. Settings for this mode can be changed in the Display tab in Advanced settings.

Note Battery-powered accessories connected to the device continue to charge while the device is in this mode and connected to AC power.

The following actions will return the display to the active state:

- Touch the screen
- Remove the temperature probe from the probe well
- Attach the SpO2 sensor to a patient
- Connect the patient movement cable and bed sensor (sensing unit) to the device
- Attach a sampling line to a patient
- Press 

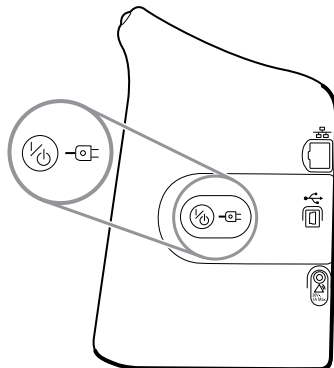

Power on/Display power-saving button

The Power on/Display power-saving button , located on the device housing, performs the following functions:

- Powers up the device
- Opens an onscreen Power-down dialog with options to Power down, Sleep, or Cancel (brief press)
- Sets the device into Display power-saving (Sleep) mode (brief press followed by 30 seconds of inactivity)

Note The device will not enter the Sleep (Display power-saving) mode while an alarm condition is active or when NIBP intervals or continuous measurements are in progress. The device also exits this mode if an alarm occurs.

The LED in the center of the power plug symbol indicates the battery charging status:

- Green indicates that AC power is present and that the battery is fully charged.
- Amber indicates that AC power is present and that the battery is charging.

Power up the monitor

The monitor runs a brief diagnostic self-test each time it powers up.



WARNING To ensure patient safety, listen for two audible indicators (a beeper and a speaker tone) and watch for visual alerts at power-up at least once daily. Correct any system errors before using the monitor. In addition to the audible indicators, the screen status area displays color coding, icons, and messages that help you to distinguish clinical priority and actions, if needed.

Type of alert	Color
High Alarm	Red
Medium Alarm	Amber
Low Alarm	Amber
Very Low Alarm	Cyan
Information message	Blue



WARNING Amber indicates a low-level alarm. Flashing amber indicates a medium-level alarm. Flashing red indicates a high-level alarm.



WARNING Always observe the monitor during power-up. If any display fails to illuminate properly, or if a system fault code or message displays, inform qualified service personnel immediately, or call your nearest Welch Allyn Customer Service or Technical Support facility. Do not use the monitor until the problem is corrected.



CAUTION Always use the monitor with an adequately charged and properly functioning battery.



CAUTION During intervals monitoring, keep the monitor connected to AC power at all times.



CAUTION Use only a Class I (grounded) AC power cord to charge the battery for this monitor.

Press the **Power** button to power up the monitor.

Following a successful self-test, the monitor displays the Welch Allyn logo and a power-up tone sounds.

A pop-up screen appears, depending on your configuration and functionality:

- On initial power-up, you are prompted to set the language, date, and time, for the monitor. See “Change the language” and “Set the date and time” for directions.
- Depending on your configuration, either the login/profile selection screen or the Home screen appears.
- If prescriptive login is not selected, then the first screen you see is the screen.
- If Bluetooth® is enabled, a list of paired devices and the option to add a new device is available.

Change the language

1. Touch the **Settings** tab, and then touch **Playground**.
The language screen appears.
2. From the drop-down menu, select your language.
3. Touch **Home** to return to the Home screen.

Set the date and time

Depending on your facility's configuration, the date and time may already be set. If the time is set in the network configuration, this network time overrides any manual time that is set.

1. On the left of the screen, touch the **Date / Time** tab.
The **Date / Time** screen appears.
2. Set the date and time, and then touch **Home**.
The Home screen appears.

Note The date and time stamps on saved patient measurements will adjust in response to new date and time settings.

Power down the monitor

This power-down method, which places the monitor into Standby mode, ensures that patient measurements are retained in the monitor memory for a maximum of 24 hours. These saved measurements are available for recall or sending electronically to the network. This method also ensures that any configuration settings you have changed and saved will be maintained at the next startup.

1. Touch the **Settings** tab.
2. Touch the **Device** tab.
3. Touch **Power down**.

If there is a software update available, a system message asks if you want to upgrade the software.

4. If you want to upgrade the software, touch **OK**.

The monitor continues to charge the battery when in Standby mode.

Reset the monitor

If the monitor stops functioning, you can press and hold  for approximately 6 seconds to allow the hardware to completely cycle off and to reset the monitor configuration settings to the last saved default power-up configuration. The button is located on the side of the monitor and on the front of the wall system.



CAUTION Do not use a long press of  to power down the monitor or wall system when it is functioning normally. You will lose patient data and configuration settings.

Enter clinician information

1. Go to the Clinician tab using one of these methods:
 - On the Home tab, touch the Clinician ID section of the Device Status area (top left corner of the screen).
 - Touch the **Settings > Clinician** tab.
2. To enter the clinician name, touch , located at the right of the text field, and enter characters.

You can enter up to 32 characters for the clinician's first and last name. Enter only 1 character for the middle initial.
3. To enter the clinician ID, use one of these methods:
 - Touch  and enter the ID.
 - Scan the clinician's barcode with a barcode scanner.

Note

If "Require clinician ID match to save measurements" is enabled in Advanced settings, a progress indicator appears in the Device Status area as the device queries an external host system for a matching ID.

- An unsuccessful query results in the message, "Unable to identify clinician."
 - A successful query results in clinician data replacing the progress indicator according to preferences configured in Advanced settings.
4. If prompted, enter your system password in the Authentication pane.
 5. Touch **OK** to save your entries and return to the Home tab.

Navigation

The monitor screen provides the interface that you use to complete your workflow. You access the monitor's features by touching the screen.

Home tab

The Home tab includes the following areas:

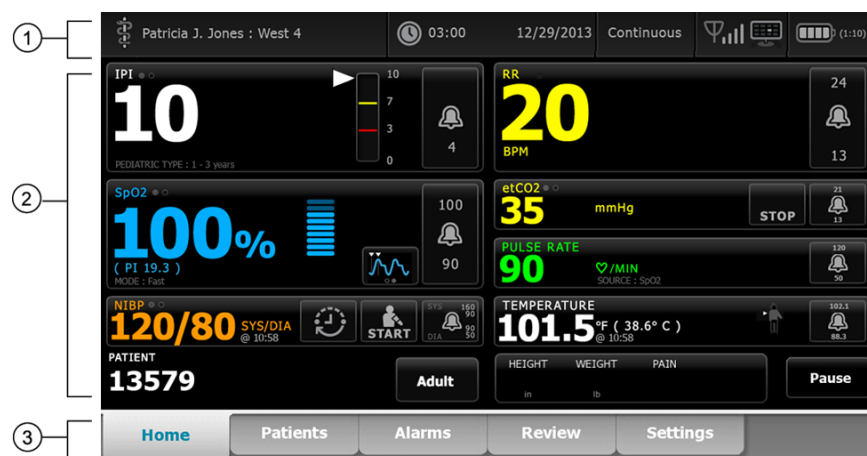

Item	Area
1	Device Status
2	Content
3	Navigation



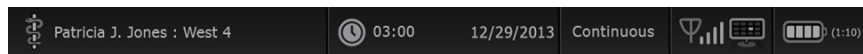



Device Status area



The Device Status area, located at the top of the Home screen, displays the following monitor information, from left to right:

- Clinician identification. The format can be a name, ID number, or icon. Touch this area to navigate to the Clinician login.
- Device location.

- Time and date. Touch this area to navigate to date and time settings.
- Current profile. Touch this area to navigate to the Profiles vertical tab (on the Device tab), which displays available profiles.
- Connection status (wired or wireless, and central station). The icons indicate which connections, if any, are currently attempted or active.

Icon	Connection type or indicator
	Ethernet
	USB
	Wireless
	Wireless signal strength
	Attempting to connect to the central station
	Connected to central station
	Not connected to central station
Blank	No connection

- Battery condition. Estimated battery capacity is displayed in hour(s):minute(s) format. Touch this area to navigate to the Device tab, where you can power down the device.

This area also provides interactive alarm and information messages, including a Demo mode active indicator.

Battery status

The battery status indicator displays the state of the battery.

The battery status is represented by icons in the right corner of the Device Status area:

- The monitor is connected to a power outlet and the battery is charging or is fully charged. The estimated charge rate is displayed as a percentage of capacity.

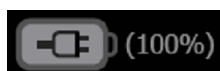

- The monitor is not connected to a power outlet and is running on battery power. The estimated charge time remaining is displayed in the hour(s):minute(s) format. Each section of the battery status indicator represents a percentage of remaining charge.



Note When the battery switches from AC power to battery power, no charge time is displayed while the device calculates the remaining charge time.

- The monitor is connected to a power outlet but the battery does not maintain a charge or has been removed.



When the battery is not being recharged and power becomes low, a very low-priority alarm appears in the Device Status area.

 **Low battery 30 minutes or less remaining.**

Note Observe the remaining battery charge in the battery status indicator and plug the monitor into a power outlet as soon as you are able.

If the very low-priority alarm is dismissed or if you take no action to charge the battery, a high-priority alarm appears when battery power is critically low. Plug the monitor into a power outlet immediately to prevent it from powering down.

 **Low battery 5 minutes or less remaining.**

Failure to plug in the monitor before the remaining charge runs out causes the monitor to power down and lose all unsaved data.

Alarm and information messages

The Device Status area provides alarm and information messages that are either temporary or exist as long as the condition to which the message applies remains. Alarm or information messages may also include controls and/or behavior that you can use to manage alarm and information messages.

When the monitor detects an alarm condition, an alarm message appears. When multiple alarms occur, the device provides options to manually toggle or autoscroll through a stack of messages. You can cycle through each alarm message in sequence of priority by touching the multiple alarm toggle. Alternatively, the autoscroll option displays messages in the stack for approximately 4 seconds. These messages are stacked in order of priority: the monitor displays the highest priority messages first followed by each successive alarm message in order of priority. After presenting the entire stack of alarm messages, the autoscroll feature loops back to the top priority message and repeats the entire stack unless specific alarms auto-dismiss or you reset or cancel specific alarms. In both the manual toggle and autoscroll options, when multiple alarm messages of the same priority exist at the same time, the device displays the most recent of those alarm messages first.

Information messages instruct you to interact with the monitor in a specific way or provide information that does not require action. You can dismiss an information

message by selecting the control associated with the message or waiting for the message to time out. Information messages rank the lowest in priority.

When the monitor is operating in Demo mode, which requires access to Advanced settings, the Device Status area displays an information message indicating that the Demo mode is active, as shown below.



Any alarm messages that occur in Demo mode include a clear "DEMO MODE:" prefix as well.



Content area

The Content area displays current vital sign measurements and patient identification. It also provides relevant controls.

The Content area includes the following:

- A frame for each available parameter
- The Patient frame
- The Manual parameters frame (height, weight, pain, temperature, respiration, and BMI, depending on configuration)

In the Triage, Spot Check, and Intervals Monitoring profiles, the Content area also includes a Save button, which you use to manually save current measurements to the Review tab. If your monitor is connected to an external system, you can send these patient measurements to that external system as well. You can configure your monitor to automatically send these measurements any time you press Save, or you can navigate to the Review tab and then select specific records to send to the external system.

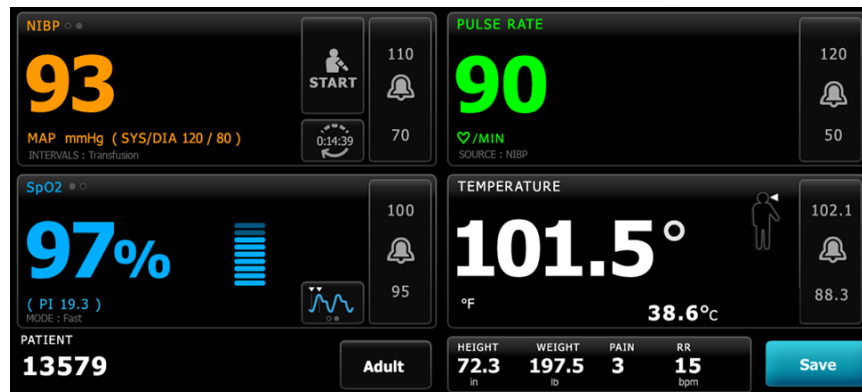

In the Continuous Monitoring profile, patient measurement data is automatically saved to the Review tab. Consequently, there is no Save button on the Home tab. (A Pause button appears in its place. See "Pause continuous monitoring (Pause mode)" in the Connex CS section of this directions for use.) If the monitor is connected to the Connex central station, the monitor automatically sends these patient measurements to the central station as well.



Navigation area



The Navigation area includes the following tabs:

- **Home:** Displays vital-sign measurements and provides shortcuts to several controls.
- **Patients:** Accesses the patient list, patient summary, and manual parameters.
- **Alarms:** Accesses global alarm response and settings controls, alarm limit settings (available only in the Intervals Monitoring and Continuous Monitoring profiles), and patient rest mode.
- **Review:** Prints, deletes, and sends patient data.
- **Settings:** Accesses device configuration settings.

To navigate to a tab, touch the tab in the Navigation area with the corresponding name. The active tab is highlighted.

Display lock

The display lock prevents clinician input, which may be useful when cleaning the display.

Note The lock feature is not a security mechanism.

The display locks when any of the following occur:

- You touch **Lock display now**.
- No interaction with the monitor occurs for the period specified in the Display tab. Use the Advanced tab to set or change the time it takes for the display to lock. (This requires the Advanced settings access code.)

Lock the display

Follow these steps to touch the screen without activating the controls.

1. Touch the **Settings** tab.
2. Touch the **Device** tab.
3. Touch **Lock display now**.

The following occurs:

- The Home screen appears.



- A title bar with a lock icon (🔒) replaces the Navigation area at the bottom of the screen.
- Patient information no longer appears at the bottom left of the screen.
- All controls on the screen are locked, except for 🔒 on the title bar. If you select any area of the screen other than 🔒, a message appears.

Unlock the display

On the locked screen, touch 🔒 in the title bar (located at the bottom of the screen).

The following occurs:

- Patient information appears in the Patient frame.
- The Navigation area appears.
- Home tab controls are available for use.

The display also unlocks when the following occur:

- An alarm condition.
- An externally initiated action, such as taking or stopping an NIBP measurement or upgrading software.
- Connecting a sampling line.

Using the keypad, keyboard, and barcode scanner

Open the numeric keypad



Touch any field that includes the numeric keypad icon .



The numeric keypad appears.

Numeric keypad



The numeric keypad includes the following components:

Component	Name	Description
	Data field	Displays the numbers you enter. The field name appears above and the range of values you can enter appears below this field.
	Backspace key	When touched, removes the rightmost number from the data field.

Component	Name	Description
	Cancel button	When touched, the numeric keypad disappears and the selected number does not change.
	OK button	When touched, the numeric keypad disappears and the entered number appears in the associated frame or data field.

Enter a number

- With the numeric keypad open, touch a number or numbers.
The value must be within the range that appears below the data field.
- Touch **OK**.
 - If the value is within the required range and format, the numeric keypad disappears and the entered numbers replace the previous numbers.
 - If the number is not within the required range and format, **OK** remains inactive until you enter a valid number.

Close the numeric keypad

Touch one of the following:

- OK**: Exits the numeric keypad and inserts the number.
- Cancel**: Exits the numeric keypad without saving entered numbers.

Open the keyboard







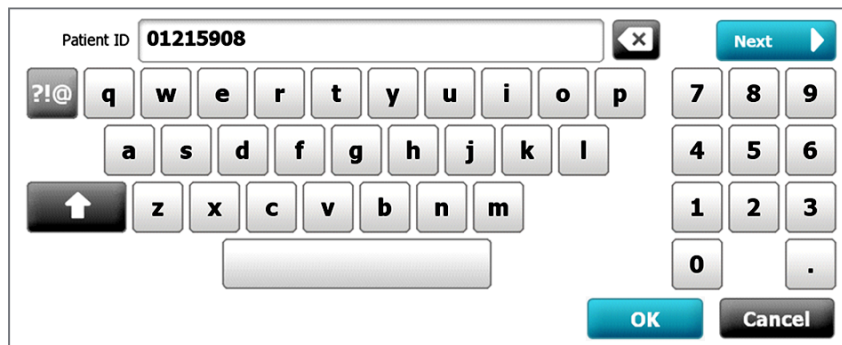



Touch any field that includes the keyboard icon .

The keyboard appears.

Keyboard



The keyboard includes the following components:

Component	Name	Description
	Data field	Displays the characters you enter. Note The keyboard can be configured to mask character entries and display them as asterisks.
	Backspace key	When touched, removes the rightmost character from the data field.
	Space bar	When touched, enters a space in the data field.
	Shift key	When touched, enters the next letter as uppercase.
	Letters key	When touched, returns to the primary keyboard layout. The keyboard changes from normal layout when you touch one of these: <ul style="list-style-type: none"> The symbols key The diacritical marks key
	Symbols key	When touched, the keyboard displays symbols. The keyboard returns to its normal layout when you touch one of these: <ul style="list-style-type: none"> Any symbol The letters key The symbols key Note The symbols that display match the selected language.
	Diacritical marks key (appearance varies in some languages)	When touched, the keyboard displays letters with diacritical marks. The keyboard returns to its normal layout when you touch one of these: <ul style="list-style-type: none"> Any letter The letters key The diacritical marks key Note This key appears only when the selected language uses diacritical marks.
	Next button	When touched, accepts the entry for the current field, then clears the field to allow data entry for the next field.
	Cancel button	When touched, the keyboard disappears and the content of the data field remains the same.
	OK button	When touched, the keyboard disappears and the entered characters appear in the data field.

Enter a letter or number

1. With the keyboard open, touch letters or numbers.
2. Do one of the following:
 - Touch **Next**. This control accepts the entry for the current field, then clears the data field to allow data entry in the next field.
 - Touch **OK**. The keyboard disappears and the entered characters appear in the data field.

Enter a symbol or special character

Note To return to the keyboard's normal layout, touch .

1. With the keyboard open, touch . Symbols and special characters for the selected language appear.

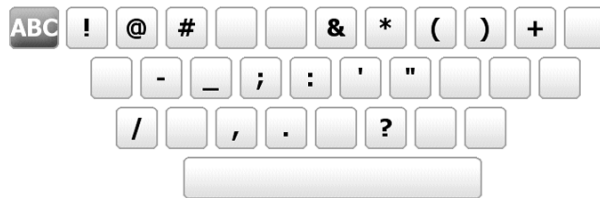



2. Touch the appropriate symbol or special character. The keyboard returns to its normal layout.



Enter a diacritical mark

Note Keyboards with diacritical marks are available only for languages that use diacritical marks.

Note To return to the keyboard's normal layout without saving changes, touch



Diacritical marks key	Language(s)
None (Not applicable)	Danish, English, Dutch, German, Italian
	French
	Finnish, Norwegian, Spanish, Swedish
	Portuguese

Diacritical marks key	Language(s)
	Polish
	Greek

1. With the keyboard open, touch the diacritical marks key. This key varies based on the language, as noted above.

The keyboard displays diacritical marks for the selected language and therefore varies from one language to another. On each diacritical marks keyboard, the letters key in the top left corner returns you to the standard keyboard.

2. Touch a diacritical mark.

The keyboard returns to its normal layout.

Close the keyboard

Touch one of the following:

- **Next:** Accepts the entry for the current field, then clears the field to allow data entry for the next field.
- **OK:** Exits the keyboard and inserts the data.
- **Cancel:** Exits the keyboard without saving entered data.

Use a barcode scanner

The monitor enables the scanning of patients' and clinicians' barcodes to enter ID information. The barcode scanner supports linear and two-dimensional barcodes.

If you haven't done so already, attach the barcode scanner to the monitor. Use the instructions to attach an accessory.

Note Refer to the manufacturer's directions for use to ensure that the scanner is set to USB Com Emulation mode.

1. Remove the barcode scanner from its holder.
2. Hold the scanner approximately 6 inches (15.4 cm) from the barcode and squeeze the trigger so that the light from the scanner appears on the barcode.

Once the scanner completes a successful barcode reading and any required queries for a matching ID on the device or in an external host system, the ID appears in the targeted area (Patient frame, data field, or Device Status area). See additional notes below.

If the scanner has difficulty reading the barcode, slowly adjust the distance and the angle between the scanner and the barcode while squeezing the scanner trigger. If it continues to have difficulty, verify that the barcode is as flat as possible.

- Note** You can scan a patient's barcode from the Home tab or the Summary tab. The scanned ID appears in the Patient frame on the Home tab and in the Patient ID field on the Summary tab. Before you scan a barcode on the Summary tab, touch the keyboard icon in the Patient ID field. To return to the Home tab and begin taking patient measurements, touch **OK**.
- Note** If "Require patient ID match to save measurements" is enabled in Advanced settings, a progress indicator appears onscreen as the device queries an external host system or the device's Patient list for a matching ID.
- An unsuccessful query results in the message, "Unable to identify patient."
 - A successful query results in patient data populating fields and appearing onscreen according to preferences configured in Advanced settings.
- Note** If "Require clinician ID match to save measurements" is enabled in Advanced settings, a progress indicator appears onscreen as the device queries an external host system for a matching ID.
- An unsuccessful query results in the message, "Unable to identify clinician."
 - A successful query results in clinician data replacing the progress indicator according to preferences configured in Advanced settings.
- Note** Scanning a clinician ID while the Clinician ID pane is open places the scanned ID into the Clinician ID section of the Device Status area. Touch **OK** to return to the Home tab and to begin taking patient measurements.
- Note** Use the Advanced settings Data Management tab to change the appearance of the Clinician ID if you do not want your ID to appear in the Device Status area. (This requires the Advanced settings access code.) However, this information is still retained in the monitor memory for recall, printing, or to send measurements electronically to the network.

Connex CS

Overview

A monitor can be used as standalone device or be networked to a central station (Connex CS). This section describes communication between the monitor and the central station.

Monitors communicate with the central station through hardwired Ethernet and wireless networks. The diagram below shows monitors connected to the central station.

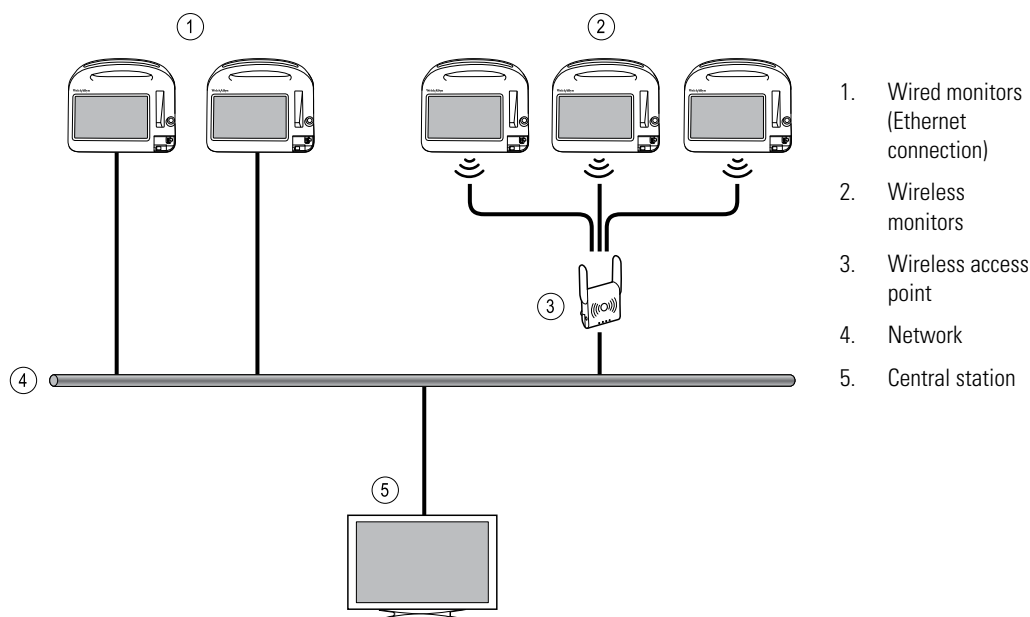

The central station provides centralized monitoring of connected monitors. This central monitoring system supports the communication of continuously monitored and intermittently acquired (episodic) data, patient vital-sign alarms, and technical equipment alerts, as well as the review and printing of all stored data.

Communication between the monitor and the central station is bi-directional but varies based on the active profile and selected advanced settings. In all profiles, for example, episodic patient data can be saved and sent to the central station, but in the Continuous Monitoring profile, patient vital-signs data streams to the central station automatically when the monitor is connected to the central station. You can enable or disable

automatic connection to the central station in Advanced settings. Furthermore, in all profiles but Triage (see Note), you can add patients to a patient list on the monitor and then send them to the central station, and you can also retrieve patient lists from a central station. In the Intervals Monitoring and Spot Check profiles, retrieving the patient list requires user action. In the Continuous Monitoring profile, the patient list on the monitor updates automatically when the monitor is connected to the central station.

Note The Triage profile does not include a Patients tab and therefore does not provide a patient list.

Once you assign a patient to a monitor and send this information to the central station, you can edit patient information on the monitor as noted in the following table:

Editable patient information based on profile and central station communication	Patient ID	Patient name	Patient location	Patient type
Spot Check and Intervals profiles	X	X	X	X
Continuous Monitoring profile, communicating with the central station			X	X
Continuous Monitoring profile, not communicating with the central station		X	X	X

Note In many cases, changing patient information opens an onscreen dialog asking you to confirm the action. These dialogs appear whenever the action results in clearing patient measurement data or patient context.

If a monitor loses its connection to the central station, the device continues to monitor the patient, display patient data, and generate alarms and messages. When connectivity is restored, the monitor resumes sending vital-signs trends and episodic data.

Monitor tab

The Monitor tab provides the following controls related to continuous patient monitoring at the device and the streaming of patient vital-signs data to a central station:

- End Monitoring – Stop continuous monitoring on the current patient and clear patient data on the device.
- Pause – Pause continuous monitoring as well as alarms for a specified period and retain patient data on the device.
- Change pause interval – Increase or decrease the pause interval in 15 minute increments up to 2 hours.
- Connect to central station – Manually connect to a central station and start or resume the streaming of patient vital-signs data when the device does not connect automatically.
- Disconnect from central station – Manually disconnect the device from a central station yet continue monitoring the patient and retain patient vital-signs data on the device. This control is only available after connecting to a central station.

The sections which follow provide instructions for using these controls.

Note This tab is visible only when the Continuous Monitoring profile is active. It is not available in the Triage, Spot Check, or Intervals Monitoring profiles.



Note The Continuous Monitoring profile is available only on devices with a Continuous Monitoring profile license.

Connect to the central station

To connect the monitor to a central station over a wireless or Ethernet network connection while in the Continuous Monitoring profile, you must first enable the **Connect to CS** option in Advanced settings. When this control is enabled, the monitor automatically attempts to connect to the central station and continues to do so until a connection is achieved.

If the Continuous Monitoring profile is active but your device has been disconnected from the central station (you will see the  indicator in the Device Status area), you can restore the connection manually.

1. Touch the **Settings** tab.
The Monitor tab appears.
2. Select  **Connect to central station**.

As the monitor attempts to connect to the central station, a  appears in the Device Status area until a connection is achieved. When the monitor connects to the central station, the  indicator appears.

The Connect to CS control described above only impacts the Continuous Monitoring profile, but you can configure Intervals Monitoring and Spot Check profiles to communicate with a central station as well in Advanced settings. In these configurations, if either the Intervals Monitoring or Spot Check profile is active, your device connects to the central station when you retrieve a patient list or load a patient's previously saved records with a barcode scanner. In addition, you can send episodic data to the central station when you touch Send on the Patient Review tab.

Disconnect from the central station

Disconnecting from the central station enables you to stop streaming data to the central station yet continue monitoring your patient, retaining patient vital signs data on the monitor. Select this option when you need to transport a patient yet continue monitoring them.

1. Touch the **Settings** tab.
The Monitor tab appears.
2. Select  **Disconnect from central station**.
If reasons for disconnecting from the central station have been configured in Connex CS, a Disconnect dialog appears with a list box of reasons.
3. Select a reason for disconnecting, if applicable, then touch **OK**.
The Home tab appears.

Continuous patient monitoring

Your device must be configured with the Continuous Monitoring profile to perform continuous patient monitoring.

Key terms

Patient context	Condition in which a patient ID and patient type have been selected on a device.
Location context	Condition in which a room or a room and bed have been selected on a device.

You have the option to continuously monitor patients on the device alone (primary monitoring) or to stream continuous patient data to a central station as well (secondary monitoring).

If Continuous Monitoring has been configured as the default profile, then the device starts up in this profile. If the Continuous Monitoring profile is active, you can proceed with an existing patient and/or location context, or you can assign a patient and location.

Activate the Continuous Monitoring profile

If the Continuous Monitoring profile is not active, follow these steps:

1. Touch the **Settings** tab.
2. Touch the **Device** tab.

The Profile vertical tab appears.

3. Select **Continuous Monitoring**.

When neither patient nor location context are established and no patient measurements have been taken or saved, the Continuous Monitoring profile immediately becomes active. If these conditions do not apply, proceed to step 4.

4. Using the conditions presented in boldface text, select and follow the steps below that apply to your patient and the device.

- a. **When patient and/or location context are established but no patient measurements have been taken or saved:**

A confirmation dialog appears asking you to confirm the patient and/or location context information or select a new patient. For example, if both patient and location context have been established, the following options appear:

- Same patient, same location
- Same patient, different location
- New patient

Select the desired option and touch **OK**.

- b. **When patient and/or location context are established and patient measurements have been taken or saved:**

A confirmation dialog appears with the following message: "Changing to the Continuous Monitoring profile deletes all measurement data from the device. Continue anyway?"

1. Touch **Yes** to confirm or **No** to cancel the profile change.

Note Selecting **No** enables you to send captured vitals data on the device before changing profiles. After you complete that task, if applicable, repeat steps 1 to 3.

Another confirmation dialog appears asking you to confirm the patient and/or location context information or select a new patient. For example, if both patient and location context have been established, the following options appear:

- Same patient, same location
- Same patient, different location
- New patient

2. Select the desired option and touch **OK**.

The profile change immediately takes effect.

5. Touch the **Home** tab.

You can now start monitoring a patient in the Continuous Monitoring profile.

Pause continuous monitoring (Pause mode)

You can temporarily pause continuous monitoring and retain patient data on the device when your patient needs to ambulate, use the restroom, or go off the unit for a test.

Note If a low-battery alarm occurs on the device, Pause mode is not available.

Note While in Pause mode, the device retains previously stored patient data, but it does not display this data or store additional patient measurements until you exit Pause mode.

1. Touch **Pause** on the Home tab.

A "Pause" dialog appears, indicating that you have paused continuous monitoring. Controls on this screen provide options to resume or end monitoring. A countdown timer displays the time remaining before continuous monitoring resumes.

Note You can configure the Pause Mode timeout in Advanced settings.

2. To increase the pause interval, repeatedly touch the **+** symbol until the desired length of time appears.

The pause interval is automatically applied.

Resume continuous monitoring

You can resume continuous monitoring after a pause when patient sensors are connected to a patient. The status of the pause timer determines your next step.

Pause time remaining

If the pause time limit has not expired (time remains on the countdown timer), resume monitoring as follows:

1. Reconnect patient sensors to the patient as needed.
2. Touch **Resume monitoring**.

The Home tab appears and continuous monitoring resumes.

Pause time limit expired (patient sensors connected)

If the pause time limit has expired and you have already reconnected patient sensors to the patient and/or the device, the Home tab appears and continuous monitoring automatically resumes.

Pause time limit expired (patient sensors disconnected)

If the pause time limit runs out before you resume monitoring, the device exits Pause mode, and alarms might occur.

Reconnect patient sensors to the patient and/or device and acknowledge alarm and information messages as needed.

Continuous monitoring resumes.

End continuous monitoring

When you no longer need to monitor a patient continuously, follow these steps to end monitoring:

1. Touch the **Settings** tab.

The Monitor tab appears.

2. Touch **End monitoring**.

An "End monitoring" dialog appears with the following options:

- New patient – Clears patient and location context and review data after you remove patient sensors
- Power down – Clears patient and location context and review data, and powers down the device
- Cancel – Retains patient data and returns to Home tab

3. Select the desired option.

Note After approximately 30 seconds of inactivity, the "End monitoring" dialog disappears. If you do not respond to this dialog and continuous monitoring is interrupted, the "Confirm patient and location" dialog appears. You must respond to this dialog before continuous monitoring resumes.

4. If you select New patient, follow the onscreen prompt to remove sensors from your patient (and the device, if applicable), and then touch **OK**.

The Home tab appears.

Assign a patient and location

You can assign a patient and location after you have begun to monitor a patient's vital signs.

When you start to continuously monitor a patient on a device that has no patient context, the following information message appears in the Device Status area: "Assign patient and location."

1. In the top right corner of the screen, touch **Assign**.

The List tab appears.

Note When the monitor is connected to a central station, the monitor automatically retrieves the patient list when you navigate to the Patients tab.

2. If you see your patient's name on the patient list, select that patient entry, and then touch **Select**.

The Home tab appears with patient and/or location information filled in according to your monitor's settings.

Note If patient name or location information is missing, the monitor will prompt you to "Assign patient" or "Assign location" until that information is complete. You can monitor the patient without entering all of these details.

3. If your patient's name does not appear on the patient list, touch **Add**.

4. In the Patient pane, touch  in a field and enter patient information. Touch **Next** to cycle through the patient data fields.

Note You can use a barcode scanner to enter a patient ID in the Patient ID field. Touch  in the Patient ID field, scan the barcode, and touch **OK**.

Note If "Require patient ID match to save measurements" is enabled in Advanced settings, a progress indicator appears onscreen as the device queries an external host system or the device's Patient list for a matching ID.

- An unsuccessful query results in the message, "Unable to identify patient."
- A successful query results in patient data populating fields and appearing onscreen according to preferences configured in Advanced settings.

5. In the Location pane, select an available room and bed from the list box.

Note The Location list only presents locations that are not already assigned to a continuous monitoring device.

"No location assigned" appears in the list box until you select a room and bed.

6. Touch **OK** to return to the Home tab.

The information is saved.

Note You have the option to leave some fields blank on the Patient > Summary tab. However, if patient name or location information is missing, the monitor will prompt you to "Assign patient" or "Assign location" until that information is complete. You can monitor the patient without entering all of these details.

Profiles

Profiles are variations of the Home tab. Each profile gives you access to a different set of features. Choose the profile that best suits your needs.

The monitor offers multiple profiles—including Continuous Monitoring, Intervals Monitoring, Spot Check, and Triage—based on the configuration and any upgrade licenses you purchase.

Continuous Monitoring profile

The Continuous Monitoring profile is designed for continuous patient monitoring. Monitors configured with Oridion Microstream Capnography provide continuous monitoring of end-tidal CO₂ (etCO₂), fraction of inspired CO₂ (FiCO₂), respiration rate (RR), pulse rate, and Integrated Pulmonary Index (IPI). Monitors configured with the Nellcor pulse oximetry option provide continuous monitoring of oxygen saturation of hemoglobin (SpO₂) and pulse rate. Monitors configured with the Masimo rainbow SET option may provide continuous monitoring of oxygen saturation of hemoglobin (SpO₂), total hemoglobin (SpHb or SpHbv), Acoustic Respiration (RRa), and pulse rate. Monitors configured with EarlySense provide continuous monitoring of respiration rate (RR), pulse rate, and patient movement.

The Continuous Monitoring profile also enables you to take manual temperature or NIBP readings, to use alarms and timed intervals, and to use bi-directional controls to transmit data between the monitor and a central station.

- Note** Patient data continuously streams to a central station only in the Continuous Monitoring profile.
- Note** If "Allow profile change" is enabled in Advanced setting, the device attempts to change to the Continuous Monitoring profile automatically when a continuous sensor (CO₂, RRa, EarlySense) is attached to the device. (See "Change to the Continuous Monitoring profile: Automatic profile change" later in this section.)

Oridion CO2-based Home tab

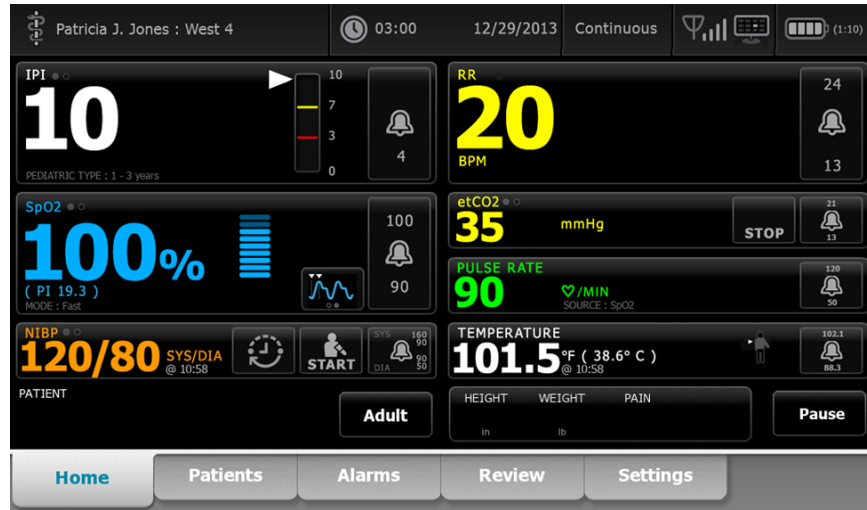

Masimo RRa-based Home tab

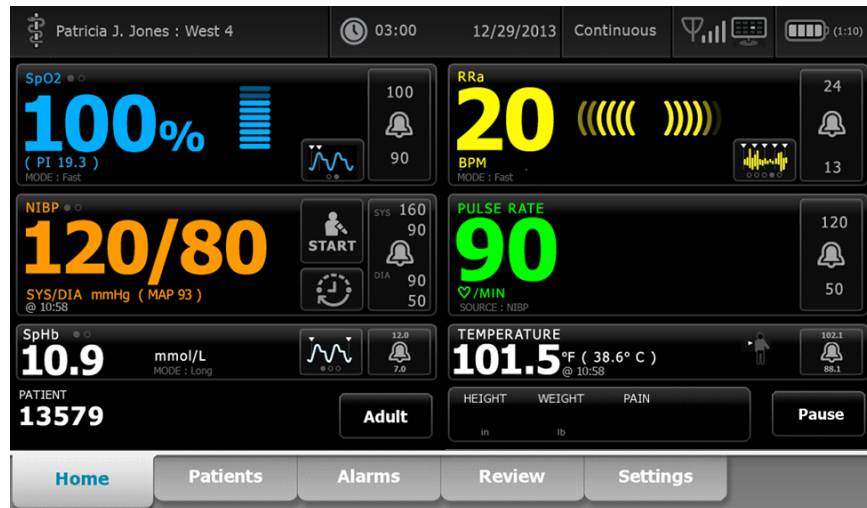

EarlySense patient movement-based Home tab

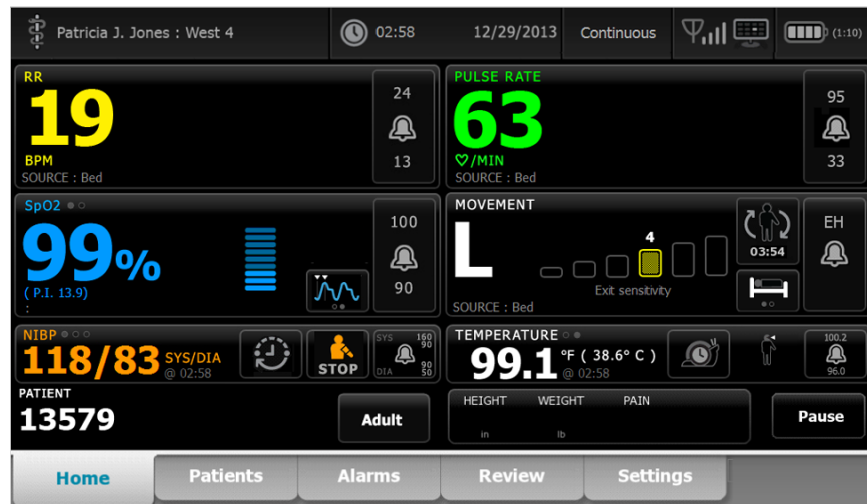

Saving vital sign measurements (Continuous Monitoring profile)

In the Continuous Monitoring profile, measurements are automatically saved as follows:

- Continuous measurements (SpO₂, SpHb, pulse rate, etCO₂, FiCO₂, IPI, respiration rate, and patient movement) are saved once per minute.
- When any measurements fall outside of alarm limits, all continuous measurements are saved.
- NIBP and predictive temperature measurements are saved when acquired.
- Manual parameters are saved when you touch the OK button on the Manual tab.
- Modifiers are set when you complete parameter setup and return to the Home tab. These modifiers do not appear on the Review tab.

After 24 hours of data has been saved for the selected patient, any data older than 24 hours is deleted from the monitor.

Note The monitor does not retain Direct mode temperatures in memory. Therefore, it is important to note the temperature before removing the probe from the measurement site and then manually record it in the patient record.

Intervals Monitoring profile

The Intervals Monitoring profile enables you to use alarms and timed NIBP intervals for patient monitoring.

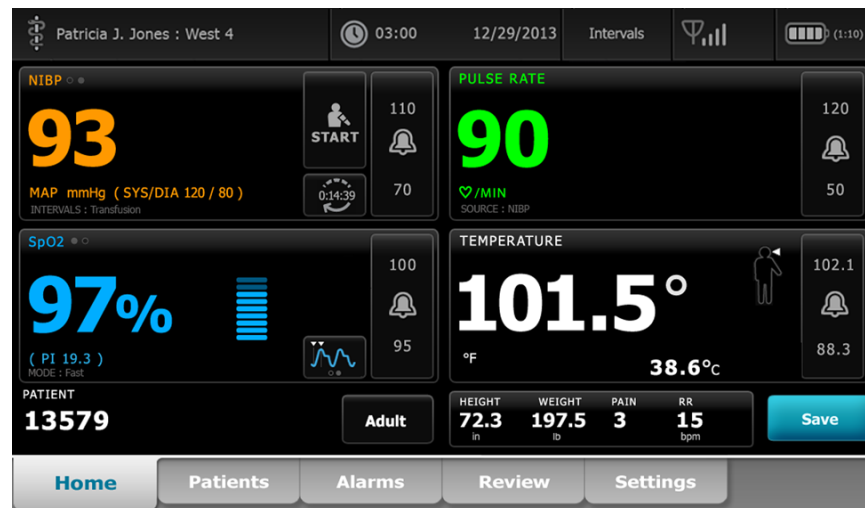

Note Patient vital signs data streams to a central station only in the Continuous Monitoring profile.

Spot Check profile

The Spot Check profile is optimized for clinicians who take spot-check vitals readings and do not need automatic reading or alarm features.

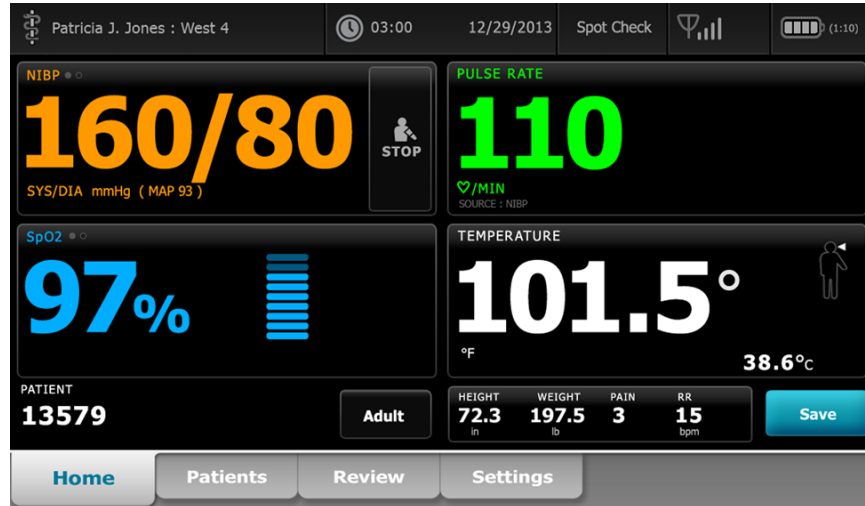

Triage profile

The Triage profile allows for vital signs capture without alarms or access to the Patients tab.



Profile feature comparison

The following table compares the features of the profiles.

Feature	Continuous Monitoring	Intervals Monitoring	Spot Check	Triage
Take NIBP, SpO2, temperature, and pulse rate measurements	X	X	X	X
Take SpHb measurements (Masimo only)	X	X		
Monitor etCO2, FiCO2, and IPI (Oridion only)	X			
Monitor RR (EarlySense and Oridion only)	X			
Monitor patient movement (EarlySense only)	X			
Monitor RRa (Masimo only)	X			
Configure and use interval timing setting	X	X		
Observe and configure alarm limits	X	X		
Observe and respond to physiological alarms	X	X		
Change patient type (adult, pediatric, neonate)	X	X	X	X
View and enter manual parameters (height, weight, pain, respiration, temperature*, BMI**)	X	X	X	
Save currently displayed vital signs data to device memory	X	X	X	X
Review saved vital signs data	X	X	X	X
Use bi-directional controls between monitor and external systems	X	X	X	X

* Braun IR thermometers configured to work with the monitor transfer temperature data automatically to the Temperature frame. You can enter temperature manually if you take a patient temperature with a thermometer that is not connected to the monitor, and you have selected temperature as one of the four manual parameters to display.

** Body Mass Index (BMI) is calculated and transferred to the monitor only by an attached weight scale. You cannot enter or adjust BMI values. BMI displays on the Manual tab and in the Manual parameters frame if you have selected it as one of the four parameters to display.

Changing profiles

You can change the active profile on the device to access a different set of features.

Note "Allow profile change" must be enabled in Advanced settings to change profiles.

The steps to change profiles vary based on several conditions:

- Active versus target profile
- Established patient context
- Saved patient measurement data
- Sensors actively collecting patient measurement data

The following table provides an overview of allowed profile changes based on these conditions.

Conditions under which specific profile changes are allowed				
Active profile	Target profile	Established patient context	Saved patient measurement data	Sensors actively collecting patient measurement data
Continuous Monitoring	Intervals Monitoring or Spot Check	X		
Continuous Monitoring	Triage	X		
Intervals Monitoring or Spot Check	Continuous Monitoring	X	X	X
Spot Check	Intervals Monitoring	X	X	X
Intervals Monitoring	Spot Check	X	X	X
Triage	Continuous Monitoring	N/A	X	X
Triage	Intervals Monitoring or Spot Check	N/A	X	X
Intervals Monitoring or Spot Check	Triage	X	X	X

Note Confirmation dialogs appear onscreen whenever a specific profile change would erase saved Review tab data, erase episodic patient measurements on the display, or potentially require changes to patient or location context.

Change from one non-continuous profile to another non-continuous profile

1. Touch the selected profile indicator in the Device Status area.

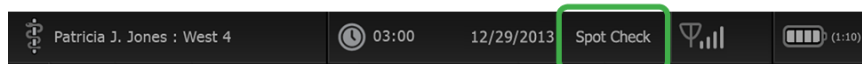

The Profile vertical tab appears.

2. Select the desired profile.

The profile change immediately takes effect.

Note For all of these non-continuous profile changes, saved episodic patient measurements remain on the Review tab, and current measurements remain onscreen. Patient and/or location context, if established, remain onscreen for all non-continuous profile changes except Triage because the Triage profile, by design, does not display patient or location context.

Change to the Continuous Monitoring profile

Automatic profile change

If "Allow profile change" has been enabled in Advanced settings, the device attempts to change to the Continuous Monitoring profile automatically when a continuous sensor (CO2, RRa, EarlySense) is attached to the device. When the profile change occurs, an information message appears in the Device Status area to report that change.

Note The profile change dialogs described in the following Manual profile change section appear onscreen as appropriate based on established patient context and/or patient measurements on the device.

Note An automatic change to the Continuous Monitoring profile occurs only once for each continuous sensor attachment. If the attempted profile change fails, or if you switch to an episodic profile after an automatic change to the Continuous Monitoring profile, you must disconnect and then reconnect a continuous sensor for another automatic change to occur.

Note If the device cannot change to the Continuous Monitoring profile, a dialog indicating that this profile is unavailable in the current configuration appears.

Manual profile change

To manually change to the Continuous Monitoring profile from any other profile, complete these steps.

1. Touch the selected profile indicator in the Device Status area.

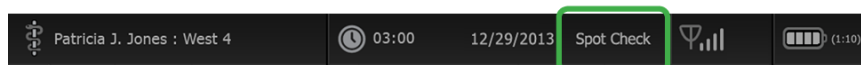

The Profile vertical tab appears. Based on the boldface text presented, select and follow the step and substeps below that apply to your patient and the device.

2. **When no patient and/or location context are established and no patient measurements have been taken or saved**, select the desired profile.

The profile change immediately takes effect.

3. **When patient and/or location context are established but no patient measurements have been taken or saved:**
 - a. Select the desired profile.

A confirmation dialog appears asking you to confirm the patient and/or location context information or select a new patient. For example, if both patient and location context have been established, the following options appear:

- Same patient, same location

- Same patient, different location
 - New patient
- b. Select the desired option and touch **OK**.
The profile change immediately takes effect.
4. **When patient and/or location context are established and patient measurements have been taken or saved:**
- a. Select the desired profile.
A confirmation dialog appears with the following message: "Changing to the Continuous Monitoring profile deletes all measurement data from the device. Continue anyway?"
- b. Touch **Yes** to confirm or **No** to cancel the profile change.
- Note** Selecting No enables you to send captured vitals data on the device before changing profiles. After you complete that task, if applicable, repeat steps 1 and 4.
- A confirmation dialog appears asking you to confirm the patient and/or location context information or select a new patient. For example, if both patient and location context have been established, the following options appear:
- Same patient, same location
 - Same patient, different location
 - New patient
- c. Select the desired option and touch **OK**.
The profile change immediately takes effect.
5. Touch the **Home** tab.
You can now start monitoring a patient in the Continuous Monitoring profile.

Change from the Continuous Monitoring profile

To change from the Continuous Monitoring profile to any other profile, complete these steps.

1. Touch the selected profile indicator in the Device Status area.

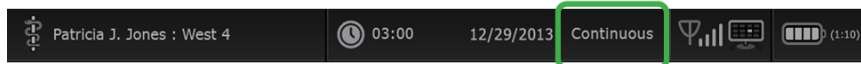

The Profile vertical tab appears. Based on the boldface text presented, select and follow the step and substeps below that apply to your patient and the device.

2. **When no patient trend data has been stored**, select the desired profile.
The profile change immediately takes effect.
3. **When continuous sensors are connected to the patient, or when episodic or continuous data has been stored**, no other profile selections are available until you remove patient sensors and end monitoring.
- a. Remove continuous sensors from your patient.
 - b. On the Settings tab, touch the **Monitor** tab.
 - c. Touch **End monitoring**.

An "End monitoring" dialog appears with the following options:

- New patient – Clears patient and location context and review data
- Power down – Clears patient and location context and review data, and powers down the device
- Cancel – Retains patient data and returns to Home tab

Note Ending monitoring deletes all patient measurement data from the device.

- d. Select the desired option and touch **OK**.

The Home tab appears.

- e. Repeat step 1 and select the desired profile on the Profile vertical tab.

The profile change immediately takes effect.

4. **When patient and/or location context are established, but no episodic or continuous trend data has been stored:**

- a. Select the desired profile.

A confirmation dialog appears asking you to confirm the patient and/or location context information or select a new patient. For example, if both patient and location context have been established, the following options appear:

- Same patient, same location
- Same patient, different location
- New patient

- b. Select the desired option and touch **OK**.

The profile change immediately takes effect.

Note If the device was connected to a central station while the Continuous Monitoring profile was active, changing to any other profile disconnects the device from the central station.

Patient data management

Patient demographic data is managed on the Patients tab.

From this tab, you can do the following:

- Retrieve a patient list from the network (for example, electronic medical records (EMR) or a central station).
- Select a patient from the list.
- Manually create patient entries and a patient list.
- Scan a patient ID with the barcode scanner and return a patient name match from your host system.

Note The patient name match could come from EMR or a central station.

- Enter additional patient information such as manual parameters.
- Assign a patient and location to device only or to a central station during continuous monitoring.





CAUTION Verify patient identity on the monitor after manual or barcode entry and before printing or transferring patient records.

Add a patient to the patient list

Note If the monitor is configured to retrieve the patient list from the network and is in the Spot Check or Intervals Monitoring profile, you cannot manually add a patient to the patient list.

Note If the monitor is configured to retrieve the patient list from the central station and is in the Continuous Monitoring profile, you can add a patient to the patient list and transfer it to the central station.

1. Touch the **Patients** tab.
2. Touch **Add**.
3. Touch  and then enter patient information. Touch **Next** to cycle through the patient data fields.

Note You can use a barcode scanner to enter a patient ID in the Patient ID field. Touch  in the Patient ID field, scan the barcode, and touch **OK**.

4. Touch **OK** to return to the Home tab.

The information is saved.



CAUTION Verify patient identity on the monitor after manual or barcode entry and before printing or transferring patient records.

Load patient data with a barcode scanner

You can use a barcode scanner to query existing patient records and perform a patient name match with the host system.

Note If the monitor is connected to the network, the monitor can receive a patient name from patient records associated with a scanned ID number.

Note If "Require patient ID match to save measurements" is enabled in Advanced settings, a progress indicator appears onscreen as the device queries an external host system or the device's Patient list for a matching ID.

- An unsuccessful query results in the message, "Unable to identify patient."
- A successful query results in patient data populating fields and appearing onscreen according to preferences configured in Advanced settings.

1. Ensure that you are on the Home tab.
2. Scan the patient's barcode with the barcode scanner.

The Patient ID appears in the Patient frame if the patient query is successful.



CAUTION Verify patient identity on the monitor after manual or barcode entry and before printing or transferring patient records.

Select a patient

The options for selecting previously stored patients from the List tab vary based on the following conditions:

- Active profile
- Established patient context
- Connection to a network
- Connection to a central station

Based on the boldface text presented, follow the steps below that apply to your patient and the device.

1. **In all profiles but Triage, when patient context has not been established on the device and patient type remains the same:**

- a. Touch the **Patients** tab.

The List tab appears.

- b. If the monitor is connected to the network, touch **Retrieve list** to update the onscreen patient list.

The monitor retrieves the patient list from the network.

Note When the monitor is connected to a central station, the monitor retrieves the patient list when you navigate to the Patients tab.

- c. Touch the patient's identifier (name, ID number, or location) you want to select.

Note Patient data can be sorted in ascending or descending order by selecting the heading row and touching ▲ or ▼. If a sort marker does not appear in a column, touch the heading, and the ▲ appears.

- d. Touch **Select**.

The selected patient's identifier appears on the Home tab.

Note As long as you make no change to patient type, any displayed patient measurements remain onscreen and are associated with the selected patient, and patient configuration settings are retained.

2. **In the Intervals Monitoring and Spot Check profiles, when patient context has been established on the device and you want to select a different patient (change patient context):**

- a. Touch the **Patients** tab.

The Summary tab appears.

- b. Touch the **List** tab.

- c. If the monitor is connected to the network, touch **Retrieve list** to update the onscreen patient list.

The monitor retrieves the patient list from the network.

Note You can enable the monitor to retrieve the patient list from the network in Advanced settings. When this feature is enabled, a **Retrieve list** button replaces the **Add** button on the List tab.

Note When the monitor is connected to a central station, the monitor automatically retrieves the patient list when you navigate to the Patients tab.

- d. Touch the patient's identifier (name, ID number, or location) you want to select.

Note Patient data can be sorted in ascending or descending order by selecting the heading row and touching ▲ or ▼. If a sort marker does not appear in a column, touch the heading, and the ▲ appears.

- e. Touch **Select**.

The selected patient's identifier appears on the Home tab.

Note All displayed patient measurements and configuration settings are cleared.

3. **In the Continuous Monitoring profile, when patient context has been established on the device and you want to select a different patient (change patient context), you must end monitoring before selecting/assigning a different patient.**

- a. Touch the **Settings** tab.

The Monitor tab appears.

- b. Touch **End monitoring**.

An "End monitoring" dialog appears with the following options:

- New patient – Clears patient and location context and review data after you remove patient sensors
- Power down – Clears patient and location context and review data, and powers down the device
- Cancel – Retains patient data and returns to Home tab

- c. Touch **New patient**.

- d. Complete step 1.

Note If patient context has been established and you attempt to select a new patient by navigating to the **List** tab, the device displays the message, "Patient already assigned to device. To assign a different patient, end monitoring for the current patient."

Manage patient records (Continuous Monitoring profile)

In the Continuous Monitoring profile, the Review tab enables access to a trend table of all readings for the currently selected patient. You can configure the time intervals displayed, and you can scroll through the last 24 hours of patient measurements. Trend data can be printed from this tab.

1. Touch the **Review** tab.

Note Measurements that triggered a physiological alarm are highlighted on this tab.

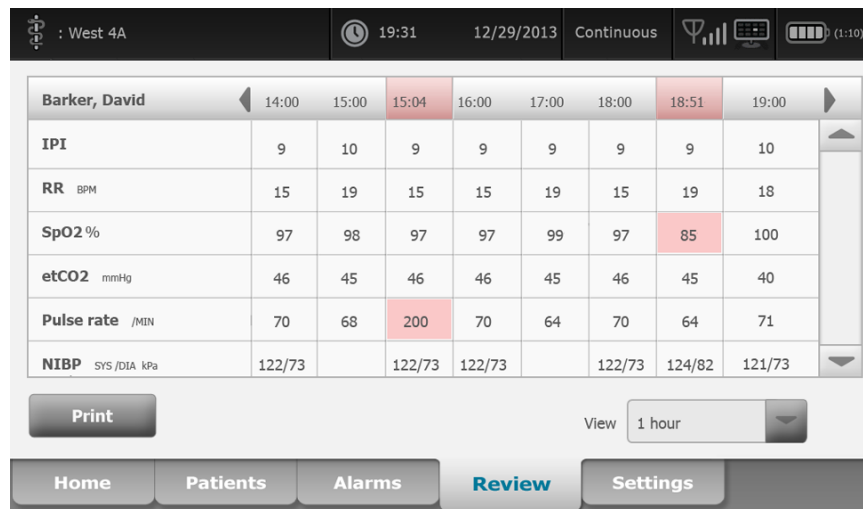

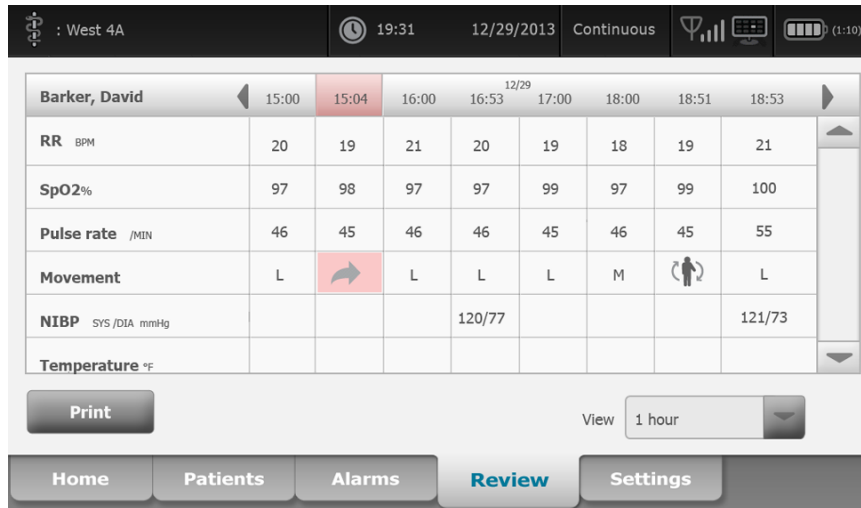

If your device is configured to monitor patient movement, the Review tab might resemble the following example.



2. Modify the trend interval (the progression of time displayed horizontally in the table) by using the View listbox. Trend interval options are 1, 5, 15, and 30 minutes; 1, 2, 4, or 8 hours; and alarms only. The default trend interval is 1 minute.

Note Event data (e.g., physiological alarms, patient movement, manual NIBP or temperature measurements, Manual parameter entries) is displayed in all trend intervals. By modifying the trend interval to one of the longer time spans, you can filter out non-alarming, continuous measurements between the currently selected time intervals to focus more attention on event data. Alternatively, you can modify the trend interval by selecting a shorter time span to display a more comprehensive listing of continuous measurements.

3. Use the scroll bar on the right to view patient measurements for any parameters that do not fit in the display area.

4. Touch the page forward  and page backward  controls in the table header to view additional measurements for this patient. The most recent measurements appear on the right of the table, with older measurements to the left.

5. Touch **Print** to print the patient's record.
A Print options dialog appears.
6. Select the desired Timespan and touch **Print**.

Note If no patient is selected, the Continuous Monitoring profile is not active, and no measurements have been taken, all table cells in the Review tab remain blank.

Note In the Continuous Monitoring profile, you cannot delete saved patient measurements. Patient measurements older than 24 hours are automatically deleted from the Review tab.

Note The date and time stamps on saved patient measurements will adjust in response to new date and time settings.

Note In the Continuous Monitoring profile, the Send option is not available on the Review tab.

Manage patient records (Intervals Monitoring, Spot Check, and Triage profiles)

Patient records can be sent to the network, printed, or deleted in these profiles.

Note Because the Patient tab is not available in the Triage profile, records saved in the Triage profile contain only vital signs measurements. Even without patient identification, these records can be sent to the network, printed, or deleted.

1. Touch the **Review** tab.

Note Measurements that triggered a physiological alarm are highlighted on this tab.

	Patient name	Date / Time	NIBP	Temp	PR	SpO2	SpHb	Ht	Wt	P	RR
<input type="checkbox"/>	Barker, David A	12/29/2011 11:22	145/100 (101)	100.8	90	99	11.8	54.1/123.5/4/38			
<input checked="" type="checkbox"/>	Smith, David A	12/29/2011 10:00	132/98 (96)	101.1	101	98	12.1	61.2/213.5/5/28			
<input type="checkbox"/>	204 A	12/29/2011 9:31	135/99 (100)	99.8	98	98	13.6	48.7/196.9/1/22			
<input type="checkbox"/>	8704330177	12/29/2011 8:44	120/80 (96)	101.1	97	97	14.9	68.5/271.4/1/28			
<input type="checkbox"/>	Carter, Grace C	12/29/2011 7:55	145/100 (101)	101.1	98	99	15.1	74.1/200/3/23			
<input type="checkbox"/>	Murphy, Michael	12/29/2011 6:58	132/98 (96)	99.8	97	97	16.8	72.4/188.2/8/40			

Send Print Delete View All

Home Patients Alarms **Review** Settings

2. Select records: by touching the check box.
3. Touch **Send** to transmit the records to the network, **Print** to print the records, or **Delete** to permanently remove the records as desired.



CAUTION Verify patient identity on the monitor after manual or barcode entry and before printing or transferring patient records.



CAUTION Always visually verify the printed patient records.

Note The  icon indicates the records have been sent to the network.

Note You can configure some profiles and settings to automatically send measurements to the network.

Note Patient measurements older than 24 hours are automatically deleted from the Review tab.

Note The date and time stamps on saved patient measurements adjust in response to new date and time settings.

Printer

The monitor prints to a strip to create printouts of patient information and data.

Note The sample printouts below are English, but the language in the printouts is defined by the language selected on the monitor.

Patient:	ID: 13579
Room/Bed:	Clinician:
SYS/DIA (MAP) PR	SpO2 Temp
(mmHg)	(BPM) (%) (°F)

12/31/2011 @ 07:46	78 97
12/31/2011 @ 07:46	86/55 (65) 78 97
12/31/2011 @ 07:46	110/71 (84) 82 97
12/31/2011 @ 07:46	102/63 (76) 78 97
12/31/2011 @ 07:46	105/67 (79) 80 96
12/31/2011 @ 07:46	100/64 (76) 77 97

Intervals Monitoring report

Patient:	ID: 13579
Room/Bed:	Clinician:
12/31/2011 @ 08:53	
SYS	106 mmHg
DIA	68 mmHg
MAP	81 mmHg
PR	71 BPM
SpO2	??
Temp	97.8 °F
Height	177.8 cm
Weight	68.0 kg
Pain	0
RR	12 bpm

Spot Check report

Patient:	Page 1	09/11/2012	23:57	23:58	23:59	00:00	00:01	00:02	*
ID: 13579	NIBP	mmHg	111/69(83)	120/80(90)					*
Type: Adult	SpO2	%	93	100	94	95	96	99	*
Room/Bed: 256 B	SpHb	g/dL	10.7	7.4	7.0	7.2	9.3	13.1	*
Clinician: 987-65-4321	PR	/MIN	58	60	56	71	60	56	*
	etCO2/FiCO2	mmHg	11(1)	33(0)	35(0)	34(0)	37(0)	38(0)	*
Vital Signs Table	IPI		9	9	10	9	9	8	*
09/12/2012 00:02	RR	/MIN	19	13	13	14	15	14	*
View: 1 min	Temp	°F		98.5					*
Timespan: 5 min	Weight	lb	168						*
	Pain		4	10			3		*

Continuous Monitoring trend data report with capnography

ID: 13579	Page 1	08/06/2013	10:12	10:13	10:14	10:15	10:16	10:17	*
Type: Adult	NIBP	mmHg							*
Room/Bed:	SpO2	%							*
Clinician:	PR	bpm	60	60	40	65	65	65	*
	Temp	°F							*
	RR	BPM	12	40	15	15	15	15	*
	Weight	lb							*
Vital Signs Table	Pain								*
08/06/2013 10:17	Movement		L	0	M	Exit	H	EH	*
View: 1 mins	Trend change					X			*
Timespan: 1 Hour									*

Continuous Monitoring trend data report with patient movement

Delete a patient from the list

1. Touch the **Patients** tab.

2. From the List tab, touch the patient record you want to delete.
3. Touch **Delete**.

At the Delete Confirmation window, touch **OK** to permanently delete the selected patient. Touch **Cancel** to cancel the deletion.

Note Deleting a patient from the Patients List does not delete saved records. Touch the **Review** tab to see or delete saved records.

Note For monitors connected to the network, deleting a patient on the monitor does not affect data on the network.

Alarms

The monitor presents physiological alarms and technical alarms. Physiological alarms occur when vital sign measurements fall outside of set alarm limits, but they occur only in the Continuous Monitoring and Intervals Monitoring profiles. Technical alarms occur when there is a problem with the monitor, an accessory connected to the monitor, or the network. Technical alarms occur in all profiles.

The monitor can communicate alarms to the following external systems:

- Nurse Call systems
- Welch Allyn software systems (Connex CS and Connex VM)



WARNING The monitor is the primary alarming source for the patient, and any external system (such as a Nurse Call or Connex CS) is a backup alarm source. The external system is only as reliable as its network and can be relied on only as a backup alarming device.



WARNING When the monitor is not connected to a secondary alarm system during continuous patient monitoring, check the monitor regularly to receive patient data, alarms, and alerts.

Note

USB is not intended for remote communication of continuous parameters and continuous alarms. Ethernet and wireless are intended for communication of vital signs parameters, patient data, and alarms (including continuous and episodic parameters and alarms) to secondary remote viewing and alarming systems.

Alarm types



Type	Priority	Color	Alarm audio tone
<ul style="list-style-type: none"> NIBP, SpO₂, SpHb, etCO₂, respiration, pulse rate, or IPI limit exceeded No breath detected Some technical alarms 	High	Red	10-pulse tone
<ul style="list-style-type: none"> Patient has exited the bed 	High	Red	Alternate 10-pulse tone
<ul style="list-style-type: none"> Temperature or FiCO₂ limit exceeded Extremely high motion Some technical alarms 	Medium	Amber	3-pulse tone
<ul style="list-style-type: none"> Some technical alarms 	Low	Amber	2-pulse tone or 1-pulse tone at 30-second intervals
<ul style="list-style-type: none"> Technical alarms that don't impact patient safety 	Very low	Cyan	2-pulse tone or 1-pulse tone at 5-minute intervals

Icons on the Home tab

Icons in parameter frames

The icons in the parameter frames indicate alarm notification settings. When alarm limits are on, the icons are black and white until an alarm occurs. Then, the icons change color to indicate the priority of the alarm. Red icons represent high-priority alarms, and amber icons represent medium- or low-priority alarms.

Icons in parameter frames

Icon	Name and status
	<p>Alarm off.</p> <p>No visual or audio alarms occur for this parameter.</p> <p>You are fully responsible for maintaining awareness of the patient's condition.</p>
	<p>Alarm on.</p> <p>Audio and visual notifications are enabled.</p>
	<p>Alarm audio off.</p> <p>Only visual notifications occur.</p> <p>If the patient is being monitored continuously, maintain a clear line of sight with the monitor while audio alarms are disabled.</p>





Icons in parameter frames

Icon	Name and status
	Alarm audio paused. The audio tone is paused. The icon remains until the paused time counts down to 0.

Icons in the Device Status area

The icons in the Device Status area are black and white, but the background area changes colors to indicate the alarm priority. Messages accompany these icons. These icons can be controls or status indicators.

Icons in the Device Status area

Icon	Name and status
	Alarm active. One or more alarms are active. Touch this icon to reset (pause or turn off) the alarm tone.
	WARNING Do not pause or turn off an audible alarm if patient safety might be compromised.
	Alarm audio off. Audio signals are disabled, but alarm limits and visual alarm signals remain active. If the patient is being monitored continuously, maintain a clear line of sight with the monitor while audio alarms are disabled.
	Multiple alarms toggle. Touch this icon to cycle through the messages for each active alarm.
	Alarm audio paused. The audio tone is paused. The icon remains until the paused time counts down to 0. Touch this icon to start the user-configured pause interval (set in the Advanced tab).

Patient rest mode

Patient rest mode enables you to turn the audio off and dim the screen of the device when continuous monitoring is enabled and a device is connected to the Central Station. The visual alarms indication on the device will display, and audible alarms will sound at a compatible Welch Allyn host with visual indications. The device may still be used for additional vitals capture. Touch the screen to remove the dimming while in use. If a loss of connectivity occurs, certain alarms become audible until connectivity is restored.

Patient rest mode can be enabled and disabled from the Central Station or from the device. If patient rest mode is initiated from the Central Station, the mode can be disabled at the Central Station or at the device. If patient rest mode is initiated from the device, it must be disabled at the device.

Patient rest mode location on the monitor

Access the rest mode on the Alarms tab.



CAUTION Loss of power will cause the monitor to return to default settings. Each time you power up the monitor, you must set alarm limits appropriate for your patient.

Turn on patient rest mode

To turn on the patient rest mode from the device:

1. Touch the **Alarms** tab.
The Alarms screen appears.
2. On the Alarms screen, touch **Patient rest mode on**.
The patient rest mode is activated.

Turn off patient rest mode

To turn off the patient rest mode from the device:

1. Touch the **Alarms** tab.
The Alarms screen appears.
2. On the Alarms screen, touch either **Alarm audio on** or **Alarm audio off**.
The patient rest mode is deactivated.

Reset (pause or turn off) audio alarms



WARNING Do not pause or turn off an audible alarm if patient safety might be compromised.

Audio alarm characteristics

- After you reset an audio alarm, some tones do not return, but others return after a pause interval if the condition that caused the alarm persists.
- If a new alarm condition occurs during a pause interval, a new audio tone occurs.
- If an audio alarm is not paused or turned off after a period of time, a buzzer accompanies the tone.

Pause or turn off an audio alarm



1. In the Device Status area, touch .
 - Visual indications remain in the parameter frame until the condition is corrected, the next measurement is taken, or the alarm is cancelled.

- In the Device Status area, if the icon changes to  and the message remains, the timer counts down a fixed pause interval of 60 seconds. The alarm tone returns after the pause interval.

A longer pause interval can be configured in the Advanced tab. You start the

configured pause interval by touching .

If you responded to an NIBP alarm and multiple NIBP limits have been exceeded, the alarm tone pauses, the first message clears, and the next NIBP limit message appears with a countdown timer. A new NIBP alarm tone sounds

after the countdown unless you touch  to dismiss each remaining NIBP limit message.

2. If multiple alarms are active, a multiple alarm toggle appears in the Device Status area. The monitor will either autoscroll through the alarm messages, displaying each for approximately 4 seconds in order of priority, or you can move through the alarms manually. Respond to multiple alarms manually as follows:

- a. Touch  to pause all audio alarms.

The alarm icon changes to  and the timer counts down a fixed pause interval of 60 seconds. The alarm tone returns after the pause interval.

- b. Touch  in the Device Status area to view each alarm in the stack.

Note The multiple alarm toggle button displays the number of active alarms inside the alarm icon. A set of dots indicating the display order of alarms from highest (left) to lowest (right) priority (as well as the most recent in the case of multiple alarms of the same priority) appears below it.

Cancel a paused alarm

You can clear a paused alarm from the Home tab. If the condition that caused the alarm persists, a new alarm appears with visual and audio notification.

1. On the Home tab, touch the alarm limits control in the selected parameter frame.

The Alarms tab for that parameter appears.



2. Touch .

The alarm clears.



3. Touch .

4. Touch the Home tab and confirm that  appears in the parameter frame.

Adjust vital sign alarm limits

You can adjust vital sign alarm limits or turn off alarm limit checking for individual parameters.



WARNING Alarm limits are patient-specific. For alarms to function properly, you must set or verify alarm limits appropriate for each patient. Each time the monitor is powered on, you must check that the alarm settings are appropriate for your patient before you start monitoring.



CAUTION Loss of power will cause the monitor to return to default settings. Each time you power up the monitor, you must set alarm limits appropriate for your patient.

1. On the Home tab, touch the alarm limits control in the selected parameter frame. For





example, to adjust the NIBP alarm limits, touch

2. Adjust vital sign alarm limits.

- To adjust a limit: Enter the desired upper and lower alarm limits using the up/down arrow keys or the keypad.



- To turn alarm limits off or on for the vital sign: Touch  or . This button toggles to display the current alarm state. If you turn off alarm limit checking for a vital sign, no visual or audio alarm signals will occur for those limits. If alarm limit checking is off, the icon changes to



on the Home tab in the parameter frame.

Modify audio alarm notification

You can modify the volume of all audio alarms.

Note If the *Allow user to turn off general audio* option is selected in Advanced settings, you can turn off audio alarms. Whenever possible, however, do not rely on visual alarm notifications alone while monitoring patients. If the patient is being monitored continuously, maintain a clear line of sight with the monitor while audio alarms are disabled.



WARNING If you are relying on audio alarm notifications, set the volume as needed considering the environment and ambient noise levels. Verify that the alarm is audible to a clinician working at the maximum distance from the monitor.

As you are working in the Alarms tab, parameter measurements appear across the top of the tab.

1. Touch the **Alarms** tab.

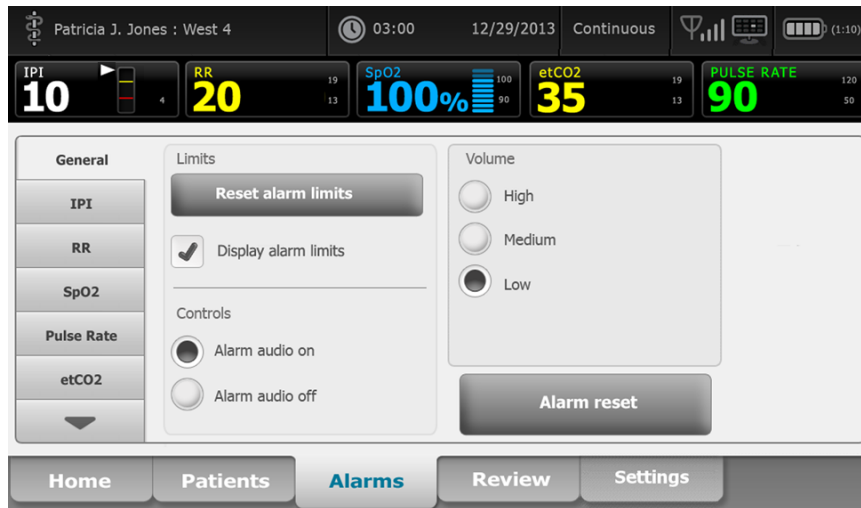

2. On the **General** tab, modify audio alarm notification.
 - To enable or disable audio alarms, select **Alarm audio on** or **Alarm audio off**. If you turn off audio alarms, visual alarm signals still occur in the LED light bar, Device Status area, and on the Home tab in parameter frames.



The  in the Device Status area indicates alarm audio turned off, and a



similar bell appears in the parameter frames . If an alarm condition occurs, the bell is red or amber in the alarming frame, according to the priority of the

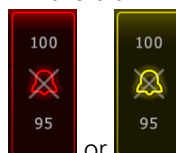

alarm, as shown here:  or .

- To modify the volume of audio alarms: Select a volume level. An audio tone sounds briefly to indicate the volume level.

Alarm messages and priorities

The following tables list the physiological and technical alarm messages and their priority.

Physiological alarms

Alarm messages	Priority
Alarm limit exceeded. etCO2 HIGH.	High
Alarm limit exceeded. etCO2 LOW.	High
Alarm limit exceeded. FiCO2 HIGH.	Medium
Alarm limit exceeded. IPI LOW.	High
No breath detected. Exceeded time limit since last breath.	High
Alarm limit exceeded. Respiration HIGH.	High
Alarm limit exceeded. Respiration LOW.	High
Alarm limit exceeded. NIBP systolic HIGH.	High
Alarm limit exceeded. NIBP systolic LOW.	High
Alarm limit exceeded. NIBP diastolic HIGH.	High
Alarm limit exceeded. NIBP diastolic LOW.	High
Alarm limit exceeded. NIBP MAP HIGH.	High
Alarm limit exceeded. NIBP MAP LOW.	High
Alarm limit exceeded. SpO2 HIGH.	High
Alarm limit exceeded. SpO2 LOW.	High
Alarm limit exceeded. SpHb HIGH.	High
Alarm limit exceeded. SpHb LOW.	High
Alarm limit exceeded. Pulse rate HIGH.	High
Alarm limit exceeded. Pulse rate LOW.	High
Alarm limit exceeded. Temperature HIGH.	Medium
Alarm limit exceeded. Temperature LOW.	Medium
Extremely high motion.	Medium

Technical alarms

Alarm messages	Priority
Low battery 5 minutes or less remaining.	High
Searching for SpO2 signal.	High
Communications module did not power on properly. Power down the device.	High
Check for occlusion in gas line.	High
Network not found; check network cable connection.	Very low
Battery is absent or faulty.	Very low
Battery is absent or faulty. Call for service.	Very low
NIBP air leak; check cuff and tubing connections.	Very low
NIBP not functional. Call for service.	Very low
Unable to determine NIBP; check connections and tubing for kinks.	Very low
Incorrect NIBP cuff size; check patient type.	Very low
Inflation too quick; check NIBP cuff and tubing connections.	Very low
Unable to determine NIBP; check connections; limit patient movement.	Very low
Unable to determine NIBP; check inflation settings.	Very low
SpO2 not functional. Call for service.	Very low
Attach SpO2 sensor to monitor.	Very low
Replace the SpO2 sensor.	Very low
Set date and time.	Very low
Maximum number of patient records saved. Oldest record overwritten.	Very low
Connect temperature probe.	Very low
Insert correct color-coded probe well.	Very low
Replace temperature probe.	Very low
Temperature not functional. Call for service.	Very low
Retry temperature measurement.	Very low
Temperature time limit exceeded. Retry temperature measurement.	Very low
Low battery, unable to print; plug into outlet.	Very low

Alarm messages	Priority
Printer door is open; close to continue.	Very low
Printer not functional. Call for service.	Very low
Out of paper.	Very low
Printer too hot; wait to retry.	Very low
Radio not functional. Call for service.	Very low
Radio error. Power down and restart.	Very low
Radio error. The radio has restarted.	Very low
Unable to establish network communications. Radio out of network range.	Very low
Unable to establish network communications. Call for service.	Very low
Radio software upgrade failed.	Very low
Unable to load configuration; using factory defaults.	Very low
Functional error. Call for service.	Very low
External device not recognized.	Very low
Incompatible Welch Allyn device.	Very low
USB Communication failure. Call for service.	Very low
Low battery 30 minutes or less remaining.	Very low
Low SpHb signal quality. Check sensor.	Very low
Low SpO2 signal quality. Check sensor.	Very low
Low perfusion. Check sensor.	Very low
Replace the SpO2 cable.	Very low
SpO2 mode only. Check sensor or cable.	Very low
SpO2 sensor expires in...	Very low
Unexpected restart occurred. Call for service.	Very low
Weight scale not functional. Call for service.	Very low
CO2 not functional. Call for service.	Very low
Filter line disconnected.	Very low
CO2 module temperature is out of range. CO2 might not be accurate.	Very low

Alarm messages	Priority
Purging filter line.	Very low
Calibration is overdue. CO2 might not be accurate.	Very low
Factory service is overdue. CO2 might not be accurate.	Very low
CO2 auto-zero in progress.	Very low
Respiratory freshness timeout expired.	Very low
Replace RRA sensor.	Very low
RRA background interference detected.	Very low
RRA patient interference detected.	Very low
File system formatted on first-time startup.	Very low
Lost connectivity with host.	Low
The patient has exited bed.	High
Patient turn overdue.	Very low
EarlySense not functional.	Very low
The sensor has expired.	Very low
The sensor is defective.	Very low
Replace the bed sensor.	Very low
The bed sensor is disconnected.	Very low
The bed sensor is upside down.	Very low
Bed sensor expires in <"1 month", "1 week", "1 day", "x hours">	Very low
Cannot measure patient. Lost or unstable signal.	Very low
Cannot measure respiration.	High
Cannot measure pulse rate.	High
Trend change detected. Review patient history.	Very low

Nurse call

The monitor can be connected to a Nurse Call system through a cable that connects to the Nurse Call connector.

When the Nurse Call cable is connected and Nurse Call is enabled, the monitor notifies the Nurse Call system when an alarm that exceeds the preset threshold occurs. Nurse Call notification persists until one of the following occurs on the monitor:

- The alarm clears.
- You reset (pause or turn off) the alarm tone.

For paused alarms, Nurse Call notification returns after the pause interval if the condition that caused the alarm persists.

Nurse Call thresholds are set in the Advanced Settings.

To connect the monitor to a Nurse Call system, you must have a cable that has been adapted to your Nurse Call system (REF 6000-NC), rated 25V AC or 60V DC maximum at 1A maximum. For ordering information, see *Approved Accessories* in the Appendix.



WARNING The monitor is the primary alarming source for the patient, and any external system (such as a Nurse Call or software system) is a backup alarm source. The external system is only as reliable as its components (e.g., wiring, hardware, light bulbs, connections) and can be relied on only as a backup alarming device.

Patient monitoring

This section of the directions for use describes the parameters available on the device, how to modify settings and alarm limits for those parameters, and how to take parameter measurements.

Before focusing on each parameter, the section addresses features that generally apply to the parameters on your device: standard and custom modifiers, and manual overrides.



WARNING When the monitor is not connected to a secondary alarm system during continuous monitoring, check the monitor regularly to receive patient data, alarms, and alerts.



WARNING Whenever possible, do not rely on visual alarm notifications alone while monitoring patients. If you must rely on visual alarm notifications, maintain a clear line of sight with the monitor. For audio alarm notifications, set the volume as needed considering the environment and ambient noise levels. Verify that the alarm is audible to a clinician working at the maximum distance from the monitor.

Standard and custom modifiers

Modifiers enable you to save additional information for the measurements for a specific patient. Standard modifiers are the same on all devices. Custom modifiers are specific to a facility or a unit, and they are set up during the initial configuration of your site.

Both standard and custom modifiers appear on the **Patients > Manual** tab.

Enter modifiers

Follow these steps to enter standard and custom modifiers.

1. Touch the **Patients** tab.
2. Touch the **Manual** tab.
3. Scroll through the list to find the parameter(s) you want to modify, then enter or select the modifier(s) as desired.
4. Touch **OK**.

The Home tab appears. In the Continuous Monitoring profile, the modifiers are saved with the next set of measurements sent to the network. In the episodic profiles, the modifiers are saved with the next set of measurements you take or with any current, unsaved measurements on the device when you touch **Save**.

Custom scoring



WARNING Risk to patient safety. Custom scores and messages serve as guides to your facility's protocols; **do not substitute custom scores for patient physiological alarms**. Appropriate alarms settings must be set and maintained to ensure patient safety.

Custom scoring enables you to configure specific parameters, based on your institution's practice standards, that calculate a score(s) for patient monitoring. This score(s) generates a message(s) regarding the patient status, based on the parameters chosen. These messages are provided only as reminders.

Configurable parameters can be accessed on the Home tab by touching **Height/Weight/Pain/RR**.

Manual overrides

The manual override feature enables you to do the following:

- input measurements when none have been recorded on the device
- replace the currently displayed measurements with measurements you take manually

Enter a manual override measurement

Follow these steps to enter a manual measurement.

1. Press and hold the selected parameter frame until a keypad appears.
2. Enter the manually acquired measurement on the keypad and touch **OK**.

The Home tab appears and displays the entered measurement.

Note Touch **Clear** to remove all values and correct your entry as needed.

Note In the Continuous Monitoring profile, measurements entered manually remain on the screen for one minute. In the episodic profiles, the manual measurement remains in the frame until the next measurement is taken.

Patient movement

Monitors configured with the EarlySense™ module continuously monitor patient movement, as well as Respiration rate (RR) and Pulse rate if licensing is enabled for these functions.

Note Respiration rate and Pulse rate measurements taken by the EarlySense module are displayed in the RR and Pulse rate frames, respectively. The frame remains blank until the sensor acquires its first measurements, which could take 1 to 2 minutes. After the initial measurement, a process indicator appears in the frame if a lost or low signal condition occurs. Lost or low signal conditions that last more than 3 minutes trigger an alarm. See the Respiration rate and Pulse rate sections of this directions for use for more information.

- Note** Monitors configured with EarlySense cannot be configured with Masimo rainbow Acoustic Respiration (RRa) or Oridion Microstream® capnography.
- Note** Patient movement monitoring is not available for neonatal/infant patients.
- Note** The EarlySense system has not been studied on any specific patient group, nor has it been studied as a tool to diagnose any specific disease of medical condition. It is an adjunctive tool used to measure respiratory rate, pulse rate, and patient movement.

Movement frame

The Movement frame displays the following data and controls used to monitor patient movement:

- Patient motion level
- Exit sensitivity
- Movement-related alarm conditions
- Patient turn events and status (time overdue or time remaining until next scheduled turn)
- Sensor source indicator



The size of the Movement frame and displayed data varies based on your configuration.

If the patient turn reminder is active, the timer counts down to zero and then displays a reminder in the Device Status area to perform and log a patient turn. If a scheduled patient turn remains overdue, a "Patient turn overdue" alarm message appears in the Device Status area, and the patient turn control is highlighted based on the priority of the

alarm (for example,  indicates a very low alarm). The timer displays a negative time until the next patient turn or the timer reaches -99:59.

Exit alarm view

The Exit alarm view is displayed automatically when an exit alarm is triggered. An exit graphic replaces the movement level and exit sensitivity indicators in the frame. The entire frame and alarm icon are highlighted based on the priority of the exit alarm.



Set up movement

The Movement vertical tab (**Settings > Setup > Movement**) presents information on the status of sensors. Only alarm settings and modifiers can be changed for this

parameter. See "Configure movement alarms" to adjust alarm settings. Follow these steps to set up movement modifiers, if applicable.

1. Touch the **Patients** tab.
2. Touch the **Manual** tab.
3. Scroll through the list to find the Movement section, then enter or select the Movement modifier(s) as desired.

Note If no modifiers are associated with this parameter, no Movement section will appear.

4. Touch **OK**.

The Home tab appears. In the Continuous Monitoring profile, the modifiers are saved with the next set of measurements sent to the network.

Configure movement alarms and patient turn reminder

Follow these steps to set alarm limits for patient movement.

1. Verify that you are using the Continuous Monitoring profile.

Note If "Allow profile change" is enabled in Advanced settings, the device attempts to shift automatically to the Continuous Monitoring profile when you connect the sensor cable.

2. Touch the **Alarms** tab.
3. Touch the **Movement** vertical tab.
4. Ensure that the Exit alarm and Motion alarm controls are set to ON.

Note If any parameter's alarm limit control is set to OFF, you cannot adjust alarm limits on the Alarm tab, and no visual or audio signals occur for that specific parameter.

5. Adjust the following settings as desired:

- **Exit sensitivity.** Use the up/down arrow keys or the keypad to choose a sensitivity level ranging from 1 to 6. Setting 1 is the least sensitive, and setting 6 is the most sensitive.

Note Levels 5 and 6 are highly sensitive and might trigger an alarm as a result of minimal movement while the patient is in bed. Correct patient assessment is the key to minimize false alerts.

- **Turn reminder.** Select the desired turn schedule from the list box.

6. Touch the **Home** tab.

The new alarm settings take effect immediately.

Monitor patient movement



WARNING Patient safety risk. Do not use heating blankets. Heating blankets could reduce the safety and efficacy of the system and void the warranty.



WARNING Patient safety risk. The EarlySense system is not intended for high-risk patients in coronary or respiratory distress who require continuous monitoring of heart function or CO₂. For these patients, the most reliable method of patient monitoring involves close personal surveillance and/or equipment suited to that type of monitoring.



WARNING Patient injury risk. The patient should not have direct contact with the bed sensor. A mattress, mattress pad, or mattress cover should always be placed as a barrier between the sensor and the patient. Check patients regularly to ensure that direct contact with the sensor does not occur.



WARNING Patient safety risk. Provide careful oversight when the EarlySense System is used with children.



CAUTION Sensor malfunction risk. Do not use EarlySense with patients who weigh more than 200 kg (440 pounds).



CAUTION Sensor malfunction or inaccurate measurement risk. Patients should not share a bed with another person during EarlySense monitoring.



CAUTION Inaccurate measurement risk. The quality of measurements might be affected by cable lengths. Do not shorten or extend the cable.



CAUTION Sensor malfunction risk. Do not allow patients to jump on the bed or the bed sensor.



CAUTION Sensor malfunction risk. For patients with poor bladder function or control, take care when placing the bed sensor under the mattress, mattress pad, or mattress cover to prevent urine from contacting the sensor.



CAUTION Sensor malfunction risk. Do not create sharp bends in the cable to prevent tearing or breaking the shielding.

1. Verify that you are using the Continuous Monitoring profile.

Note If "Allow profile change" is enabled in Advanced settings, the device attempts to shift automatically to the Continuous Monitoring profile when you connect the sensor cable.

2. Touch the patient type control on the right side of the Patient frame.
The Patient Summary tab appears.
3. Select the patient type, then touch **OK**.

Note Patient movement monitoring is not available for neonatal/ infant patients.

4. If sensor is not plugged into the device, align the EarlySense cable connector with one of the EarlySense ports on the right side of the monitor. Insert the cable connector until it clicks into place. Also check the stress relief connector on the cable to ensure that both parts of the cable are tightly connected.

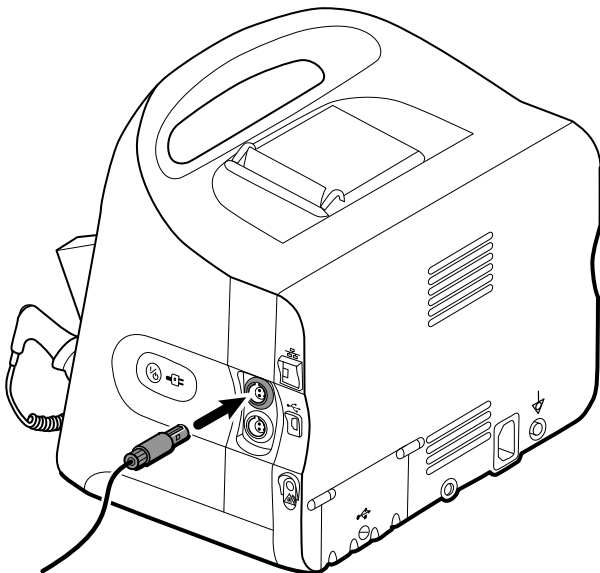

5. Position the bed sensor (sensing unit) as follows:
 - horizontally under the patient's mattress
 - the top surface of the sensing unit facing the mattress
 - the sensing unit under the patient's chest area
 - the sensing unit cable extending toward the head of the bed

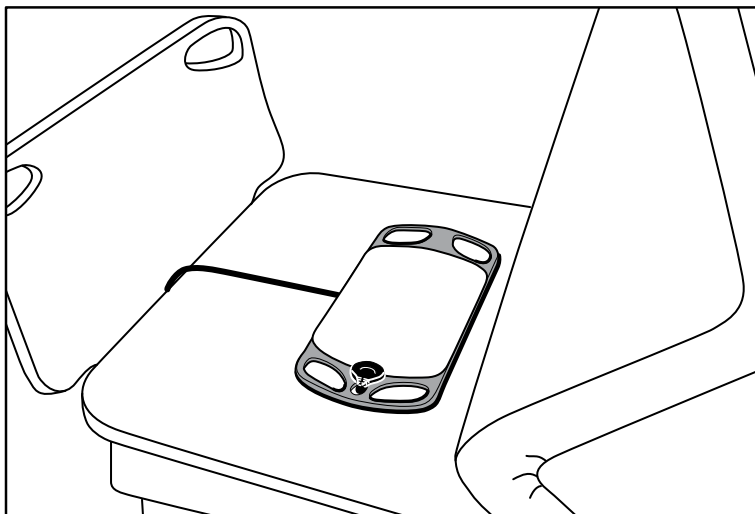

6. Instruct or assist the patient to lie down in bed. Double-check the position of the patient and the sensor (see step 5), and adjust as needed.

Note Careful placement of the sensor is key to getting quality EarlySense measurements.

7. Wait for a first measurement.

Note Patient movement, Respiration rate, and Pulse rate measurements taken by EarlySense are displayed in the Movement, RR, and Pulse rate frames, respectively. Each frame remains blank until the sensor acquires its first measurements, which could take approximately 1 to 2 minutes. After the sensor detects a patient, an initial set of measurements appears in the associated frames.

Note EarlySense alarms occur only after a good initial measurement.

Low confidence condition

After receiving a valid set of measurements for a specific patient, a low confidence condition occurs whenever the EarlySense module loses or has difficulty acquiring a



signal. During low confidence conditions, a process indicator replaces the previous reading in the Respiration rate (RR) and/or Pulse rate frames and remains in the frame until the sensor acquires a valid measurement.

Note A low confidence condition that persists beyond 3 minutes triggers a technical alarm.

Observe and report patient turn events

Based on the Turn reminder schedule configured on the **Alarms > Movement** tab, the patient turn countdown timer indicates the time remaining until the next scheduled turn. If turn reminders have been turned off, the patient turn control is disabled and the counter is blank.

Any time the patient turn button is active and the timer is running, you can report a patient turn on the device. You do not have to wait for the timer to expire.

1. On the Home tab, touch **Pause**.

Note Putting the device in Pause mode prevents triggering a bed exit alarm.

2. Turn the patient.
3. Touch **Resume monitoring**.

Note The Home tab appears.



4. Touch

The patient turn button is disabled, and the following confirmation appears in the Device Status area: "Patient turn logged and counter reset."

The patient turn button remains disabled until the updated turn status is recorded.

Capnography (CO₂)

Monitors configured with Oridion Microstream® capnography continuously measure or indicate the following:

- End-tidal CO₂ (etCO₂): the level of CO₂ in a patient's exhaled breath
- Fraction of inspired CO₂ (FiCO₂): the level of CO₂ in a patient's inhaled breath
- Respiration rate (RR)
- Integrated Pulmonary Index (IPI): a numerical value that integrates four parameters (etCO₂, respiration rate, SpO₂, and pulse rate) and indicates a patient's overall respiratory status

Note Monitors configured with Oridion Microstream capnography cannot be configured with Acoustic Respiration (RRa).

etCO₂ frame

The etCO₂ frame displays data and controls used in monitoring the level of CO₂ in a patient's breath (etCO₂ and FiCO₂). Controls to pause or restart the CO₂ pump as well as to pause CO₂ alarms also appear in the frame.

Note CO₂ monitoring is available only with the Continuous Monitoring profile.

The frame provides a numeric view and a waveform view of CO₂ data. You can toggle between views by touching the left side of the frame.

etCO₂ numeric view

The numeric view displays end-tidal CO₂ (etCO₂) and fraction of inspired CO₂ (FiCO₂) in mmHg or kPa. The size of the etCO₂ frame and displayed measurements varies based on your configuration.



CO₂ waveform view

The CO₂ capnogram waveform view displays the CO₂ waveform, enabling you to observe a patient's breathing patterns and to determine adequate, hyperventilation, or hypoventilation conditions.

The size of the etCO₂ frame and displayed measurements varies based on your configuration.



Set up etCO₂

Follow these steps to configure etCO₂ parameter settings and to set up etCO₂ modifiers.

1. Touch the **Settings** tab.
2. Touch the **Setup** tab.
3. Touch the **etCO₂** vertical tab.
4. Adjust the following settings as desired:
 - Sweep speed. Select the desired speed. You can set the default in Advanced settings.
 - Waveform scale. Select the scale using the toggle button. You can set the default in Advanced settings.
 - Pump standby time. Select the time using the toggle button.
5. Touch the **Home** tab.

The new settings take effect immediately.

6. To set up modifiers, if applicable, touch the **Patients** tab.
7. Touch the **Manual** tab.
8. Scroll through the list to find the etCO₂ section, then enter or select the etCO₂ modifier(s) as desired.

Note If no modifiers are associated with this parameter, no etCO₂ section will appear.

9. Touch **OK**.

The Home tab appears. In the Continuous Monitoring profile, the modifiers are saved with the next set of measurements sent to the network.

Configure etCO₂ and FiCO₂ alarms

Follow these steps to set alarm limits for CO₂ measurements.

Note FiCO₂ appears only if enabled in Advanced settings.

1. Verify that you are using the Continuous Monitoring profile.

Note If "Allow profile change" is enabled in Advanced settings, the device attempts to shift automatically to the Continuous Monitoring profile when you connect the sensor cable.

2. Touch the **Alarms** tab.
3. Touch the **etCO₂** vertical tab.
4. Ensure that the etCO₂ and FiCO₂ alarm limit controls are set to ON.

Note If any parameter's alarm limit control is set to OFF, you cannot adjust alarm limits on the Alarm tab, and no visual or audio signals occur for that specific parameter.

5. Adjust the following settings as desired:
 - etCO₂ limits. Enter upper and lower alarm limits for etCO₂ using the up/down arrow keys or the keypad next to the Limits control.

- FiCO₂ limit. Enter the desired upper alarm limit for FiCO₂, if activated, using the up/down arrow keys or the keypad next to the FiCO₂ control.
 - High alarm delay. For etCO₂ only, select the duration using the list box. This alarm delay specifies the minimum duration of a high alarm condition to activate an alarm signal. You can set the default in Advanced settings.
6. Touch the **Home** tab.
- The new alarm settings take effect immediately.

Measure CO₂

Before you begin, read the Microstream CO₂ sampling line's directions for use.



WARNING Loose or damaged connections can compromise ventilation or cause an inaccurate measurement of respiratory gases. Securely connect all components and check connections for leaks according to standard clinical procedures.



WARNING When using a sampling line for intubated patients with a closed suction system, do not place the airway adapter between the suction catheter and endotracheal tube. This is to ensure that the airway adapter does not interfere with the functioning of the suction catheter.



WARNING Do not cut or remove any part of the sampling line. Cutting the sampling line could lead to erroneous readings.



WARNING Inaccurate measurement or equipment malfunction risk. If too much moisture enters the sampling line (e.g., from ambient humidity or breathing unusually humid air), the message "Purging filter line" will appear in the Device Status area. If the sampling line cannot be cleared, the message "Check for occlusion in gas line" appears. Replace the sampling line when this message appears.



WARNING The sampling line might ignite in the presence of O₂ when directly exposed to lasers or high heat. When performing head and neck procedures involving lasers or high heat, use with caution to prevent combustion of the sampling line or surrounding surgical drapes.



CAUTION Only use Welch Allyn-approved CO₂ sampling lines to ensure the monitor functions properly.



CAUTION Microstream CO₂ sampling lines are designed for single patient use and are not to be reprocessed. To prevent damage to the monitor, do not attempt to clean, disinfect, or blow out the sampling line.



CAUTION Dispose of Microstream CO₂ sampling lines according to standard operating procedures or local regulations.

1. Touch the patient type control on the right side of the Patient frame.
The Patient Summary tab appears.
2. Select the patient type, then touch **OK**.
3. Select the appropriate sampling line based on the following considerations:
 - Whether the patient is intubated or non-intubated
 - Whether the patient is on mechanical ventilation
 - Duration of use

- Patient's size and weight
4. Connect the sampling line to the monitor.
 - a. Slide open the door that protects the sampling line port on the monitor.
 - b. Connect the sampling line.

Note The CO₂ pump starts as soon as the pump sensor recognizes the sampling line. This can occur before you completely connect the sampling line.

- c. Turn the connector completely to the right until tight.

An etCO₂ sampling line dialog appears on the screen to reinforce this instruction (unless the dialog is disabled in Advanced settings).



WARNING You must connect the sampling line correctly. Ensure that the connector is tight to accurately monitor CO₂.

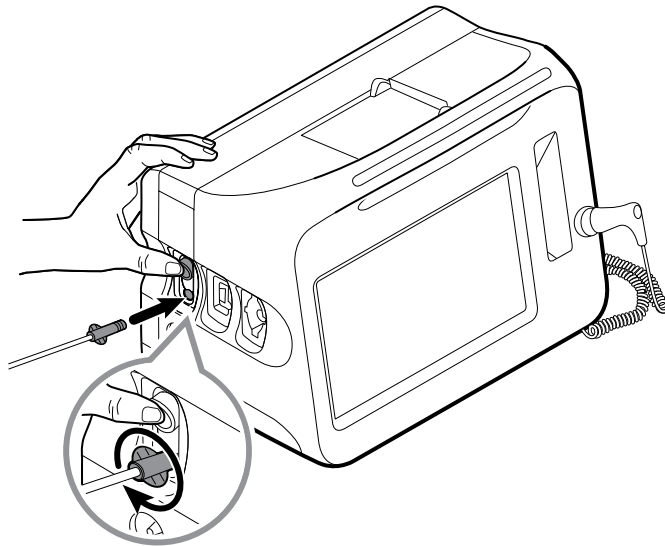

Note This secure connection prevents gases from leaking at the connection point during measurement and is essential to ensure accurate measurements.

5. If the etCO₂ sampling line dialog appears on your screen, watch the animation and confirm that you have connected the sampling line correctly, then touch **OK** to dismiss the dialog.
6. Verify that you are using the Continuous Monitoring profile.

Note If "Allow profile change" is enabled in Advanced settings, the device attempts to shift automatically to the Continuous Monitoring profile when you connect the sensor cable.

7. Connect the sampling line to the patient as described in the directions for use supplied with the sampling line.
8. Perform the following checks:
 - a. Check that CO₂ values appear on the monitor.
 - b. Check the patient type. Make sure it is correct to ensure accurate sampling.
 - c. Touch the alarm control to ensure the alarms are set appropriately.

- d. Toggle to the waveform view to ensure that a complete waveform appears.

- Note** When the cannula is not on the patient, the etCO₂ value is blank.
- Note** After you connect the sampling line, the monitor immediately searches for breaths, but it does not indicate a No Breath condition before any valid breaths have been detected.
- Note** To avoid moisture buildup and sampling line occlusion during suction or nebulization of intubated patients, stop the CO₂ pump and remove the sampling line luer connector from the monitor.
- Note** Replace the sampling line according to hospital protocol or when a blockage is indicated by the device. Excessive patient secretions or a buildup of liquids in the airway tubing might occlude the sampling line, requiring more frequent replacement.
- Note** When the message "Check for occlusion in gas line" appears on the screen, indicating that the sampling line attached to the monitor is blocked, the monitor's CO₂ pump will stop. Follow the instructions in the Troubleshooting section of this manual to correct the problem.

Stop and restart the CO₂ pump

Stopping the CO₂ pump prevents the ingress of fluids into the CO₂ module during certain patient procedures (such as suction or lavage). In addition, this pump-stop condition pauses the monitoring of all parameters obtained from the CO₂ module for a configured period of time or until you restart the CO₂ pump.

1. To temporarily pause or stop CO₂ monitoring, touch the pump-stop button  in the etCO₂ frame.

Note This button is a toggle. When you stop the CO₂ pump, the Start button with a countdown timer appears.

2. To resume CO₂ monitoring, touch the pump-start button .

The CO₂ pump restarts, the current timer clears, and the Stop button appears in the frame.

Respiration rate

RR frame

The RR frame displays the following:

- Respiration rate in breaths per minute (BPM)
- Alarm limit control

Note RR monitoring is available only in the Continuous Monitoring profile.

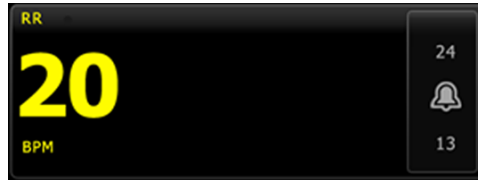

Set up RR

Only alarm delays and modifiers can be changed for the **RR** parameter. See "Configure RR alarms" to adjust alarm settings. Follow these steps to set up RR modifiers, if applicable.

1. Touch the **Patients** tab.
2. Touch the **Manual** tab.
3. Scroll through the list to find the RR section, then enter or select the RR modifier(s) as desired.

Note If no modifiers are associated with this parameter, no RR section will appear.

4. Touch **OK**.

The Home tab appears. In the Continuous Monitoring profile, the modifiers are saved with the next set of measurements sent to the network.

Configure RR alarms

Follow these steps to set alarm limits for RR measurements.

1. Verify that you are using the Continuous Monitoring profile.

Note If "Allow profile change" is enabled in Advanced settings, the device attempts to shift automatically to the Continuous Monitoring profile when you connect the sensor cable.

2. Touch the **Alarms** tab.
3. Touch the **RR** vertical tab.
4. Ensure that the RR alarm limit control is set to ON.

Note If any parameter's alarm limit control is set to OFF, you cannot adjust alarm limits on the Alarm tab, and no visual or audio signals will occur for that specific parameter.

5. Adjust the following settings as desired:
 - RR limits. Enter upper and lower alarm limits for RR using the up/down arrow keys or the keypad.
 - High alarm delay. Select the duration from the list box. This alarm delay specifies the minimum duration of a high alarm limit condition to activate an alarm signal. You can set the default in Advanced settings.
 - No breath detected alarm delay. Select the duration from the list box. This alarm delay specifies the minimum duration of a no-breath condition to activate an alarm signal. You can set the default in Advanced settings.
6. Touch the **Home** tab.

The new alarm settings take effect immediately.

IPI

The Integrated Pulmonary Index (IPI) integrates four parameters and their interactions to provide a numeric value indicating a patient's overall respiratory status. The integrated parameters are etCO₂, RR, SpO₂, and PR. The additional status information provided by IPI enables you to intervene before values of individual parameters reach levels of clinical concern.

Note IPI is available for adult patients as well as three groups of pediatric patients (1–3 years, 3–6 years, and 6–12 years), but it is not available for neonatal/infant patients.

Note Pediatric patient subtypes appear on the Patient Summary tab and on the Home tab as a label in the IPI frame, but they do not appear in the Patient frame.

Note IPI is available only with the Continuous Monitoring profile.

The range of IPI is 1–10. These values can be interpreted as indicated in the following table.

Index range	Patient status
10	Normal
8–9	Within normal range
7	Close to normal range; requires attention
5–6	Requires attention and may require intervention
3–4	Requires intervention
1–2	Requires immediate intervention

Source: *The microMediCO₂ Module - OEM Manufacturers' Integration Guide* (p. 13), Oridion Medical 1987 Ltd.

Note The interpretation of a patient's IPI value might change in different clinical conditions. For example, patients who have a history of respiratory difficulties might require a lower IPI Low Alert threshold that takes into account their diminished respiratory capacity.

IPI frame

The IPI frame displays a numeric value from 1–10 as well as an alarm threshold and control.

The frame provides a numeric view and a graphical trend view of IPI data. You can toggle between views by touching the left side of the frame.

IPI numeric view

This view displays the numeric value for the integrated parameters.



The numeric view also includes a graphic indicator of the patient's current IPI value. As shown in the examples below, when the IPI value is 8, 9, or 10, the outline of the vertical bar is gray. When the IPI value is 4, 5, 6, or 7, the outline of the bar is yellow, and the middle section of the bar is shaded yellow. When the IPI value is 1, 2, or 3, the outline of the bar is red, and the lowest section of the bar is shaded red.

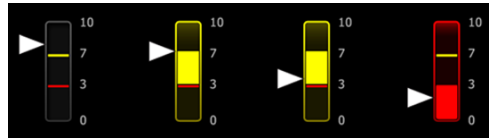

IPI trend graph view

This view presents a graph of the IPI numeric values over a user-selected period and thus can alert you to changes in the patient's respiratory status. In Advanced settings, you can select the period displayed.

The size of the IPI frame and displayed trend data varies based on your configuration.

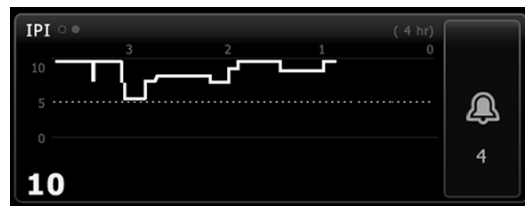

The graph shows the IPI value on the y-axis and time on the x-axis (oldest calculations on the left and newest calculations on the right). IPI values update once every second.

Set up IPI

Follow these steps to configure IPI parameter options.

1. Touch the **Settings** tab.
2. Touch the **Setup** tab.
3. Touch the **IPI** vertical tab.
4. Adjust the Trend period as desired. You can set the default in Advanced settings.
5. Touch the **Home** tab.

The new settings take effect immediately.

6. Touch the patient type control on the right side of the Patient frame.

The Patient Summary tab appears.

Note IPI is available for adult patients as well as three groups of pediatric patients (1–3 years, 3–6 years, and 6–12 years), but it is not available for neonatal/infant patients.

Note If you are monitoring a pediatric patient, the following additional considerations apply when you select patient type: Pediatric patients fall into one of three types based on their age: Ped 1–3, Ped 3–6, Ped 6–12. Because these age ranges overlap, consider details such as patient size and birth date to select Pediatric patient type.



CAUTION The characteristics of a breath are calculated differently for different patient types. Incorrect patient type selections cause inaccurate monitoring of the patient's respiration rate and affect the patient's IPI value.

7. Touch the Type list box and select patient type.

Note If you select Pediatric as a patient type, an information message prompts you to select a pediatric age range when you monitor IPI on pediatric patients, as shown here.

8. Touch **OK**.
The Home tab appears.

Note Pediatric patient subtypes appear on the Patient Summary tab and on the Home tab as a label in the IPI frame, but they do not appear in the Patient frame.

Configure IPI alarms

Follow these steps to set alarm limits for IPI.

1. Verify that you are using the Continuous Monitoring profile.

Note If "Allow profile change" is enabled in Advanced settings, the device attempts to shift automatically to the Continuous Monitoring profile when you connect the sensor cable.

2. Touch the **Alarms** tab.
3. Touch the **IPI** vertical tab.
4. Ensure that the Limits control is set to ON.

Note If any parameter's alarm limit control is set to OFF, you cannot adjust alarm limits on the Alarm tab, and no visual or audio signals will occur for that specific parameter.

5. Adjust the IPI limits setting as desired. Enter the desired lower alarm limit for IPI using the up/down arrow keys or the keypad.
6. Touch the **Home** tab.

The new alarm settings take effect immediately.

Acoustic respiration rate (RRa)

Monitors configured with Masimo rainbow Acoustic Monitoring technology continuously and noninvasively measure respiration rate based on respiratory sounds produced in the upper airway. Respiratory sounds are detected through a sensor applied to the patient's neck.

Note RRa is available only in the Continuous Monitoring profile.

Note Masimo SpO2 monitoring is required when monitoring RRa.

Note RRa monitoring is only for adult patients who weigh more than 66 pounds (30 kilograms).

Note Monitors configured with RRa cannot be configured with CO2.

RRa frame

The RRa frame displays the following:

- Respiration rate in breaths per minute (BPM)
- Respiration Indicator
- Alarm limit control
- Averaging control toggle providing the options of slow, medium, fast, trending, and off

Note RRa is available only when the Continuous Monitoring profile and Adult patient type are selected.



Respiration Indicator

The Respiration Indicator displays the level of sound detected by the RRa sensor. A higher level of sound causes more bars to illuminate.



Averaging selector

The averaging selector enables you to choose the desired visibility of subtle variations in RRa measurements. You can adjust averaging in the RRa frame by touching the



averaging selector. Use this control toggle to select an averaging option (off, slow, medium, fast, or trending) while acquiring readings.

Averaging selector options



Off



Fast

~10 seconds



Medium

~20 seconds



Slow

~30 seconds



Trending

~60 seconds

You can set the RRa averaging default in Advanced settings. Averaging is set to default settings when any of the following occurs:

- The device starts up
- You change or clear patient context

Set up RRa

Default settings for the **RRa** parameter can be changed only in Advanced settings.

Configure RRa alarms

Follow these steps to set alarm limits for RRa measurements.

1. Verify that you are using the Continuous Monitoring profile.

Note If "Allow profile change" is enabled in Advanced settings, the device attempts to shift automatically to the Continuous Monitoring profile when you connect the sensor cable.

2. Verify that the patient type is Adult.
3. Touch the **Alarms** tab.
4. Touch the **RRa** vertical tab.
5. Ensure that the RRa alarm limit control is set to ON.

Note If any parameter's alarm limit control is set to OFF, you cannot adjust alarm limits on the Alarm tab, and no visual or audio signals will occur for that specific parameter.

6. Adjust the following settings as desired:
 - RRa limits. Enter upper and lower alarm limits for RRa using the up/down arrow keys or the keypad.
 - Alarm delay. Select the duration from the list box. This alarm delay specifies the minimum duration of an alarm limit condition to activate an alarm signal. The

alarm delay you select impacts both upper and lower alarm limits. You can set the default in Advanced settings.

- No breath detected alarm delay. Select the duration from the list box. This alarm delay specifies the minimum duration of a no-breath condition to activate an alarm signal. You can set the default in Advanced settings.

7. Touch the **Home** tab.

The new alarm settings take effect immediately.

Measure RRa

RRa monitoring is only for adult patients who weigh more than 66 pounds (30 kilograms).



WARNING Inaccurate measurement risk. Use only Masimo rainbow SET sensors and accessories on Masimo-equipped monitors.



WARNING The accuracy of RRa measurements can be affected by any of the following:

- Excessive ambient or environmental noise
- Improper sensor placement
- Failure to properly connect the sensor and cables



WARNING Masimo SpO2 monitoring is required when monitoring RRa.



WARNING Patient injury risk. Do not attempt to reprocess, recondition, or recycle any sensors or patient cables. Doing so might damage electrical components.



WARNING Patient injury risk. The sensor and extension cable are intended only for connection to pulse co-oximetry equipment. Do not attempt to connect these cables to a PC or any similar device. Always follow the sensor manufacturer's directions for care and use of the sensor.

Before you begin, read the RRa sensor directions for use.

1. Verify that the dual cable is connected to the monitor and to the SpO2 cable and the RRa cable. If a sensor is connected to the RRa cable, disconnect the sensor from the cable.

Note When the RRa sensor is off the patient and is connected to the monitor, the sensor might pick up periodic ambient sounds and report a measurement.

2. Verify that you are using the Continuous Monitoring profile.

Note If "Allow profile change" is enabled in Advanced settings, the device attempts to shift automatically to the Continuous Monitoring profile when you connect the sensor cable.

3. Verify that the patient type is Adult.

4. Verify that the alarms are set appropriately.

5. Start monitoring SpO2 as described in this directions for use.

6. Attach the RRa sensor to the patient according to the manufacturer's directions for use, observing all warnings and cautions.

Note The sensor is for single-patient use only. You can reuse the sensor on the same patient if it is clean and dry, and the adhesive still adheres to the skin. Otherwise, use a new sensor. Do not reuse the sensor on another patient.

Note Do not use disposable sensors on patients who have allergic reactions to the adhesive.

Note A process indicator  appears in the RRa frame until an RRa measurement is available for display.

7. Connect the RRa sensor to the RRa cable.
8. Confirm that the monitor displays RRa data within approximately 60 seconds of connection to the patient.



WARNING Patient injury risk. Incorrect sensor application or excessive duration of sensor use can cause tissue damage. Inspect the sensor site periodically as directed in the sensor manufacturer's instructions.

Detaching the sensor during a measurement triggers an alarm.

NIBP

Noninvasive Blood Pressure (NIBP) frame

From the NIBP frame, you can measure blood pressure.

The NIBP frame contains data and features relevant to noninvasive blood pressure measurement. The frame provides different features based on the profile you are using.

NIBP frame in Continuous Monitoring profile



The size of the NIBP frame and displayed measurements varies based on your configuration.

The Continuous Monitoring profile also provides a visual indication of aging episodic measurements (those more than 16 minutes old) and a timestamp indicating the time of the measurement. When a NIBP measurement is displayed for more than 16 minutes, the numerics on the screen change from their current color to gray. After one hour, these measurements are cleared from the frame.

NIBP frame in Intervals Monitoring profile



NIBP frame in Spot Check and Triage profiles





NIBP measurement display

In all profiles, the frame can display systolic and diastolic measurements, and MAP calculations. You can configure the default view in Advanced settings.



View indicator





Touch the NIBP frame to toggle between views.

- NIBP view 1  displays the SYS/DIA measurements as the primary content and the MAP calculation as secondary content.
- NIBP view 2  displays the MAP calculation as the primary content and the SYS/DIA as secondary content.

Buttons

The buttons on the right side of the frame enable you to do different tasks depending on the profile you are using. The availability of functions depends on which profile is selected. See the Profiles section for more information.

Button name	Button image	Description
Start/Stop		The appearance and function of this button dynamically changes.
	Note	A process indicator  appears in the NIBP frame until the NIBP parameter has initialized.
		Touch to start a manual measurement or a cycle of automatic measurements.

Button name	Button image	Description
		Touch to stop a measurement that is in progress.
Interval		This button shows the status of automatic measurements. Touch the button to display the Intervals tab, where you can configure automatic measurements.
		Automatic measurements are off.
		Automatic measurements are on.
Alarm Limit control		This button displays alarm status. It also displays alarm limits in some device configurations.
		Touch the button to display the Alarms tab.

Select a cuff



WARNING Use only blood pressure cuffs and hoses listed as approved accessories to ensure safe and accurate NIBP measurements.



WARNING Never use an adult or pediatric monitor setting or cuff for an NIBP measurement on a neonatal patient. Adult and pediatric inflation limits can be excessive for neonatal patients, even if a neonatal cuff is used. Neonates are defined in the AAMI SP10:2002 standard as children 28 days or less of age if born at term (37 weeks gestation or more); otherwise, up to 44 gestational weeks.



CAUTION Correct sizing of the blood pressure cuff is important for accurate blood pressure readings. A cuff that is too small might provide false high readings, while a cuff that is too large might provide false low readings.

The monitor uses the oscillometric method to determine blood pressure; therefore, if the cuff extends to the antecubital fossa (bend in the elbow), you can still acquire an accurate blood pressure reading.

Before taking an NIBP measurement, follow these steps to select the appropriate cuff for the patient.

1. Measure the circumference of the patient's bare upper arm, midway between the elbow and shoulder.

2. Choose the appropriate cuff size based on the circumference measurement. If the circumference of the patient's arm falls between two cuff sizes, use the larger cuff size.
3. Wrap the cuff around the patient's bare upper arm and verify that the artery index marker lies somewhere between the two range markings on the cuff.

Cuff measurements

The following tables provide measurements for Welch Allyn blood pressure cuffs.

One-piece cuff measurements

Cuff Size	Circumference (cm)	Circumference (in)
Infant	9.0 – 13.0	3.5 – 5.1
Small child	12.0 – 16.0	4.7 – 6.3
Child	15.0 – 21.0	5.9 – 8.3
Small adult	20.0 – 26.0	7.9 – 10.2
Adult	25.0 – 34.0	9.8 – 13.4
Large adult	32.0 – 43.0	12.6 – 16.9
Thigh	40.0 – 55.0	15.7 – 21.7

Neonatal soft disposable cuffs with male Luer slips

Cuff Size	Circumference (cm)	Circumference (in)
NEO 1	3.3 – 5.6	1.3 – 2.2
NEO 2	4.2 – 7.1	1.6 – 2.8
NEO 3	5.4 – 9.1	2.1 – 3.6
NEO 4	6.9 – 11.7	2.4 – 4.6
NEO 5	8.9 – 15.0	3.5 – 5.9
Multi-pack	1 of each	1 of each

For ordering information, see *Approved Accessories* in the Appendix.

Position the cuff

Note The monitor and cuffs were validated using the bare upper arm site.



WARNING Patient injury risk. Do not use the NIBP for continuous monitoring without frequently checking the patient's limb. When a patient is being monitored frequently or for a prolonged period, regularly remove the cuff to inspect it and to check the cuff site for ischemia, purpura, or neuropathy.



WARNING Inaccurate measurement risk. Do not place the cuff where it can disturb proper circulation. Do not place the cuff on any area where circulation is compromised or on any extremity used for intravenous infusions. Do not use an SpO2 finger clip sensor and a blood pressure cuff simultaneously on the same limb. Doing so may cause a temporary loss of pulsatile flow, resulting in either no reading or an inaccurate SpO2 or pulse rate until the flow returns.



WARNING The blood pressure cuff must be properly positioned to ensure blood pressure accuracy and patient safety. Wrapping the cuff too loosely (preventing proper inflation) may result in inaccurate NIBP readings.



CAUTION If a site other than the bare upper arm is used, the blood pressure measurements may be different. It is important to document the alternate site on the patient record.



CAUTION To minimize inaccurate measurement, limit patient movement during an NIBP measurement cycle.

Before taking an NIBP measurement, follow these steps to properly attach the cuff to the patient.

1. Check the cuff for residual air from a previous measurement. Squeeze the cuff as needed to completely deflate the cuff.
2. Position the cuff on the patient's bare upper arm midway between the shoulder and the elbow.
3. Wrap the cuff snugly so that there is room for no more than two fingers between the cuff and the patient's bare upper arm.
4. Position the alignment mark on the cuff directly over the brachial artery.
5. Ensure that the blood pressure tubing has no kinks or twists.

Note

In situations where you cannot position the cuff level with the heart, you should adjust the measurements as follows for greater accuracy. For each inch (2.54 cm) that the cuff is above the level of the heart, add 1.8 mmHg to the displayed reading. For each inch (2.54 cm) that the cuff is below the level of the heart, subtract 1.8 mmHg from the displayed reading. It is important to document the adjustment on the patient record.

Set up NIBP

Follow these steps to configure NIBP parameter settings and to set up modifiers.

1. Touch the **Settings** tab.
2. Touch the **Setup** tab.
3. Touch the **NIBP** vertical tab.
4. Adjust the following setting as desired:
 - Cuff inflation target. If the monitor is set up for StepBP, enter the Cuff inflation target. You can set the default in Advanced settings.
5. Touch the **Home** tab.
The new setting takes effect immediately.
6. To set up modifiers, touch the **Patients** tab.
7. Touch the **Manual** tab.
8. Scroll through the list to find the NIBP section, then enter or select the NIBP modifier(s) as desired.
 - Cuff site. Select the site from the list box.
 - Cuff size. Select the size from the list box.
 - Patient position. Select the position from the list box.
9. Enter or select other modifier(s), if applicable, as desired.
10. Touch **OK**.

The Home tab appears. In the Continuous Monitoring profile, the modifiers are saved with the next set of measurements sent to the network. In the episodic profiles, the modifiers are saved with the next set of measurements you take or with any current, unsaved measurements on the device when you touch **Save**.

Configure NIBP alarms

Follow these steps to set alarm limits for systolic and diastolic measurements, and MAP calculation.

1. Verify that you are using the Intervals Monitoring or Continuous Monitoring profile.
2. Touch the **Alarms** tab.
3. Touch the **NIBP** vertical tab.
4. Ensure that the NIBP and MAP alarm limit controls are set to ON.

Note If any parameter's alarm limit control is set to OFF, you cannot adjust alarm limits on the Alarm tab, and no visual or audio signals will occur for that specific parameter.

5. Adjust the following settings as desired:
 - Systolic. Enter upper and lower Systolic alarm limits using the up/down arrow keys or the keypad.
 - Diastolic. Enter upper and lower Diastolic alarm limits using the up/down arrow keys or the keypad.
 - MAP. Enter upper and lower MAP alarm limits using the up/down arrow keys or the keypad.

6. Touch the **Home** tab.

The new alarm settings take effect immediately.

NIBP measurement

The monitor enables you to take manual and automatic NIBP measurements.



WARNING NIBP readings may be inaccurate for patients experiencing moderate to severe arrhythmia.



WARNING Do not allow a blood pressure cuff to remain on neonatal patients more than 90 seconds when inflated above 5 mmHg. Do not allow a blood pressure cuff to remain on the adult patients more than 3 minutes when inflated above 15 mmHg. Excessive cuff tightness may cause venous congestion, peripheral nerve injury, discoloration of the limb, and patient distress.



WARNING Inaccurate measurement risk. Pulse rate measurements generated through the blood pressure cuff or through SpO2 are subject to artifact and might not be as accurate as heart rate measurements generated through ECG or through manual palpation.



WARNING Use caution when measuring blood pressure using oscillometric blood pressure devices in severely ill neonates and pre-term infants because these devices tend to measure high in this patient population.



CAUTION Inaccurate measurement risk. Any external compression of the blood pressure hose or cuff may cause system errors or inaccurate measurements.

At the start of a measurement, the monitor inflates the cuff to the appropriate level. In the NIBP frame, the systolic display shows the cuff inflation pressure while the blood pressure measurement is in progress.

The monitor measures blood pressure as the cuff is inflating. If patient movement, excessive noise, or an arrhythmia prevent the monitor from determining the blood pressure while the cuff is inflating, the monitor attempts to measure the blood pressure while deflating the cuff.

When the measurement is complete, the NIBP frame displays the measurement until you save it to the patient's record or you start another NIBP measurement.

Note The Pediatric and Adult blood pressure modes are supported on patients 29 days and older. The Pediatric mode gives you the option of setting a lower initial inflation pressure when using the StepBP deflation and not SureBP.

Note Use dual-lumen tubes for adult and pediatric blood pressure measurements and single-lumen tubes for neonate blood pressure measurements. Mismatching tube types, patient types, and algorithms causes an information message to appear in the Device Status area. For neonate patients, set the NIBP settings as follows: Patient = Neonate, Tube type = 1 tube, Algorithm = Step.

Note Welch Allyn uses the following definition of Neonate: Children 28 days or less of age if born at term (37 gestation or more); otherwise, up to 44 gestational weeks.

Take a manual NIBP measurement



WARNING Patient injury risk. Never install Luer Lock connectors on Welch Allyn blood pressure cuff tubing. Using these connectors on blood pressure cuff tubing creates the risk of mistakenly connecting this tubing to a patient's intravenous line and introducing air into the patient's circulatory system.



CAUTION Inaccurate measurement risk. Any external compression of the blood pressure hose or cuff may cause system errors or inaccurate measurements.

1. Properly size the blood pressure cuff and position it around the patient's bare upper arm.



2. Touch  to take a measurement.

Cancel a measurement that is in progress

Follow these steps to cancel any NIBP measurement that is in progress.



On the Home tab, touch .

The monitor rapidly deflates the cuff, and the screen displays the NIBP cancellation message.

Interval NIBP measurement

The monitor can take NIBP measurements automatically based on intervals you choose.

The Intervals tab provides all interval features.

From this tab, you can do the following:



- Configure intervals
- Turn off intervals
- Configure the monitor to print automatic measurements as they are completed

When the measurement is complete, the NIBP frame displays the measurement until the next measurement starts.

Note In the Intervals Monitoring profile, each time automatic interval measurements are saved, manual parameter and predictive temperature measurements are cleared from the screen. When you manually save any patient measurements in this profile, all patient measurements are cleared from the screen.

Note In the Continuous Monitoring profile, all patient measurements remain onscreen when automatic interval measurements are saved.



The  button changes to a timer (), which counts down to the next automatic measurement.

Automatic measurements continue until you turn off intervals.



WARNING Patient harm risk. Do not use intervals on neonates out of earshot. Verify that audio can be heard from where you intend to be.

Set up NIBP intervals

Follow these steps to configure NIBP intervals.

1. Touch the **Settings** tab.
2. Touch the **Setup** tab.
3. Touch the **Intervals** vertical tab.
4. Select **Automatic**, **Program**, or **Stat**, and follow the steps presented in the associated topics that follow.
5. To automatically print patient data at each interval, touch the **Automatic print on interval** checkbox.
6. To start intervals immediately, touch **Start intervals**. Otherwise, touch the **Home** tab.

The new settings take effect immediately.

Automatic intervals

You can configure the monitor to take automatic NIBP measurements at consistent intervals. Use the spin box or keypad to set the desired interval.

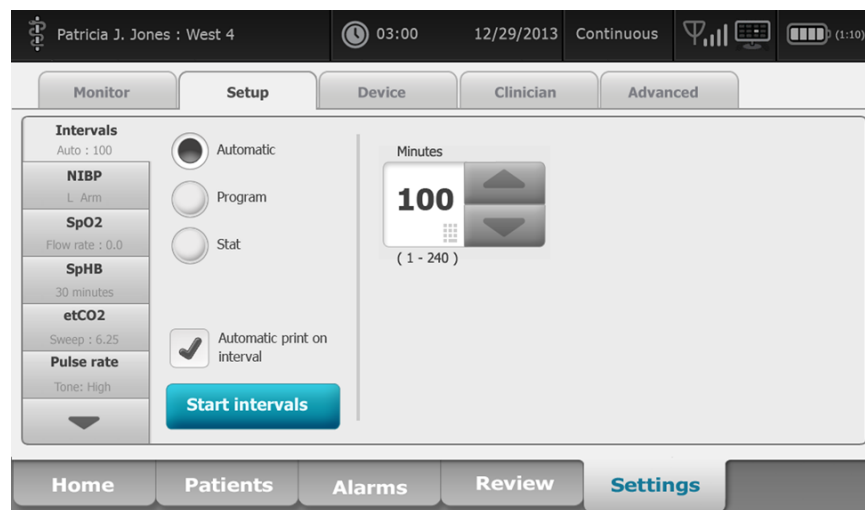

Note An alarm does not turn off intervals. Subsequent automatic measurements continue to occur as scheduled.

Start automatic intervals

Follow these steps to configure the monitor to take NIBP measurements at consistent intervals.

1. Properly size the blood pressure cuff and position it around the patient's bare upper arm.



2. On the Home tab, touch .
3. Select **Automatic**.
4. Use the numeric keypad to enter the length of time between NIBP measurements.
5. Touch **Start intervals**.

Note Intervals are not available in all profiles. See the Profiles section for more information.

Program intervals

You can configure the monitor to take automatic NIBP measurements at variable intervals. The monitor comes with preset interval programs that can be edited to meet your needs. You can rename selected programs using the keyboard feature. The columns below the selected program name indicate the length of each interval in the cycle (Interval) and the number of intervals you set (Frequency).

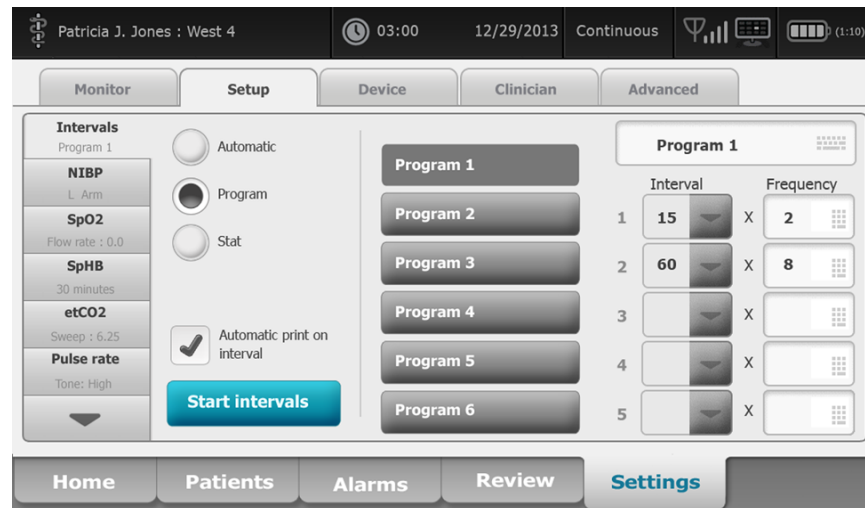

Start program intervals

Follow these steps to configure the monitor to take automatic NIBP measurements at variable intervals.

1. Properly size the blood pressure cuff and position it around the patient's bare upper arm.



2. On the Home tab, touch .
3. Select **Program**.
4. Touch the desired program.
5. Touch **Start intervals**.

Create a new program interval or edit an existing program

Follow these steps to create or edit a program interval.

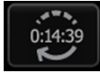
1. On the Home tab, touch the interval button ( or ).
2. Select **Program**.
3. Touch the desired program.
4. Touch the keyboard icon and enter the desired program name.
5. Enter the desired interval and frequency settings.
6. Touch **Start Intervals**.

The new intervals take effect at the start of the next NIBP measurement.

Stat intervals

You can configure the monitor to take NIBP measurements continuously.

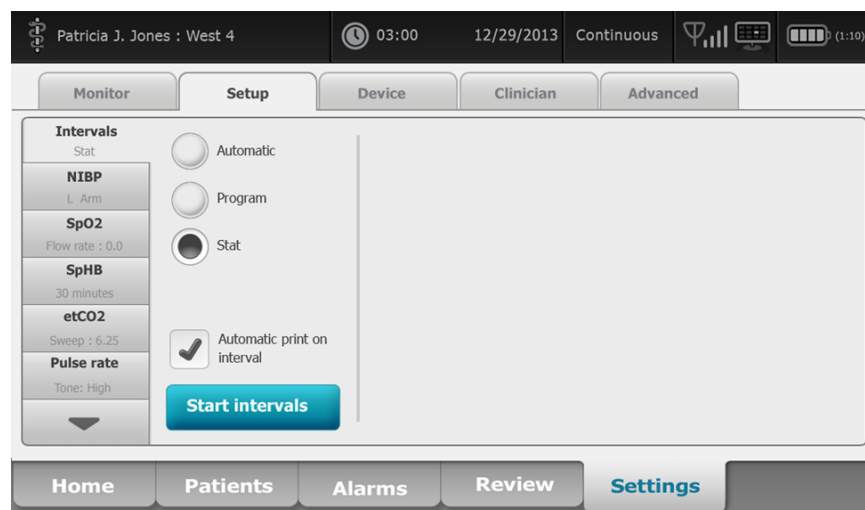

When you select the Stat option, the monitor takes repeated NIBP measurements for 5 minutes, starting a new cycle each time the cuff deflates below safe venous return pressure (SVRP) for 2 seconds.



WARNING Patient injury risk. If you use Stat mode repeatedly, periodically observe the patient's limb to ensure that circulation is not impaired and that the cuff remains in place. Prolonged impairment of circulation or improper cuff position can cause bruising.

Current cuff pressures are not dynamically displayed during a Stat reading. The Home tab displays the NIBP reading from the previous cycle until the current cycle finishes.

Note If you are in Stat intervals, you can stop intervals by touching



Start Stat intervals

Follow these steps to start Stat intervals.

1. Properly size the blood pressure cuff and position it around the patient's bare upper arm.



2. On the Home tab, touch .
3. Select **Stat**.
4. Touch **Start intervals**.

The Home tab appears with the intervals timer counting down from 0:05:00.

Stop intervals measurements

Follow these steps to turn off intervals.

1. On the Home tab, touch the interval timer button ().

Note The actual time remaining varies based on the length of the selected interval and the time expired.

2. Touch **Stop intervals**.

Note If you are in Stat intervals, you can also stop intervals on the Home tab by



touching .

Temperature

Temperature frame

From the temperature frame you can measure patient temperature.

The temperature frame contains data and features relevant to temperature measurement. The frame provides different features based on the profile you are using.

Temperature frame in Continuous Monitoring profile

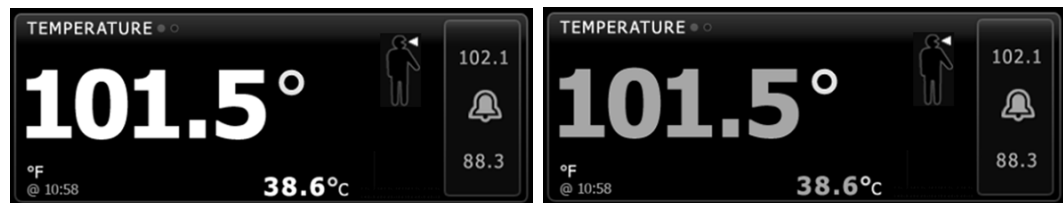

The size of the Temperature frame and displayed measurements varies based on your configuration.

The Continuous Monitoring profile also provides a visual indication of aging episodic measurements (those more than 16 minutes old) and a timestamp indicating the time of the measurement. When a temperature measurement is displayed for more than 16 minutes, the numerics on the screen change from their current color to gray. After one hour, these measurements are cleared from the frame.

Temperature frame in Intervals Monitoring profile



Temperature frame in Spot Check and Triage profiles



Temperature measurement display

In all profiles, the frame can display temperature in Celsius or Fahrenheit. You can configure the default view in Advanced settings.

Site selection

Remove the temperature probe and touch the **Temperature site control** to toggle between sites.



Pediatric axillary



Adult axillary



Oral



Note Monitors configured with the temperature module and the red rectal probe well and probe default to the rectal mode.

Rectal



Note The monitor displays the tympanic mode when it receives a temperature measurement from the ear thermometer.

Ear**Temperature buttons**

The buttons on the right side of the frame enable you to do different tasks depending on the profile you are using. The availability of functions depends on which profile is selected.

Button name	Button image	Description
Temperature alarm		<p>This button displays alarm status. It also displays alarm limits in some device configurations.</p> <p>Touch the button to display the Alarms tab.</p>
Direct mode		<p>Touch the button to enter Direct mode.</p>

Configure temperature alarms

Follow these steps to set alarm limits for temperature measurement.

1. Verify that you are using the Intervals or Continuous profile.
2. Touch the **Alarms** tab.
3. Touch the **Temperature** vertical tab.
4. Ensure that the Temperature alarm limit control is set to ON.

Note

If any parameter's alarm limit control is set to OFF, you cannot adjust alarm limits on the Alarm tab, and no visual or audio signals will occur for that specific parameter.

5. Adjust the Temperature limits as desired. Enter the desired upper and lower alarm limits for temperature using the up/down arrow keys or the keypad.
6. Touch the **Home** tab.

The new alarm settings take effect immediately.

SureTemp[®] Plus temperature module

The temperature module uses a thermistor thermometer design and a predictive algorithm to calculate patient temperatures in the Predictive mode.



WARNING Patient injury risk. Do not exceed the recommended temperature measurement durations in Direct mode. Continuous measurement durations of 3 minutes at the oral and rectal sites and 5 minutes at the axillary site are recommended for accurate measurement. Do not continuously measure beyond 10 minutes in any mode.



WARNING Patient injury risk. Inaccurate measurement risk. Oral/axillary probes (blue ejection button at top of probe) and blue removable probe wells are used for taking oral and axillary temperatures only. Rectal probes (red ejection button) and red removable probe wells are used for taking rectal temperatures only. Use of the incorrect removable probe well could result in patient cross-contamination. Use of the probe at the wrong site will result in temperature errors.



WARNING Patient injury risk. When taking rectal temperatures, insert the probe tip a maximum of 5/8 inch (approximately 1.5 cm) inside the rectum of adults and a maximum of 3/8 inch (approximately 1 cm) inside the rectum of children to avoid the risk of bowel perforation.



WARNING Inaccurate measurement risk. Always take an axillary temperature with direct contact between the probe cover and the skin. Carefully place the probe in the axilla, avoiding contact with other objects or material.



WARNING Patient injury risk. Always take a temperature measurement with a Welch Allyn single-use probe cover securely attached. Failure to use a probe cover can cause patient discomfort from a heated probe, patient cross-contamination, and inaccurate temperature readings.



WARNING Inaccurate measurement risk. To ensure optimal accuracy, always confirm that the correct mode and site are selected.



WARNING Never use a damaged temperature probe. The thermometer consists of high-quality precision parts and should be protected from severe impact or shock. Do not use the thermometer if you notice any signs of damage to the probe or monitor. If the thermometer probe is dropped or damaged, remove it from use and have it inspected by qualified service personnel.



WARNING Inaccurate measurement risk. Apply a thin layer of lubricant to probe cover, if necessary, for patient comfort. Use of excessive lubricant may affect reading accuracy.



CAUTION Inaccurate measurement risk. Patient activities such as strenuous exercise, ingesting hot or cold liquids, eating, chewing gum or mints, brushing teeth, or smoking may affect oral temperature measurements for up to 20 minutes.



CAUTION Inaccurate measurement risk. Always use new probe covers taken from the monitor's probe cover box holder to ensure accurate temperature measurements. Probe covers taken from other places or that haven't stabilized in temperature may result in inaccurate temperature measurements.



CAUTION Probe covers are disposable, nonsterilized, and single-use. Probes are also nonsterilized. Do not autoclave probes and probe covers. Ensure that probe covers are disposed of according to facility requirements or local regulations.

Temperature mode selection

The monitor with the temperature module takes a patient temperature in either Predictive (Normal) or Direct mode. The default setting is the Predictive mode.



WARNING Inaccurate measurement risk. To ensure optimal accuracy, always confirm that the correct mode and site are selected.



WARNING Patient injury risk. Do not exceed the recommended temperature measurement durations in Direct mode. Continuous measurement durations of 3 minutes at the oral and rectal sites and 5 minutes at the axillary site are recommended for accurate measurement. Do not continuously measure beyond 10 minutes in any mode.

Predictive mode

Is a one-time measurement that takes a temperature in approximately 6 to 15 seconds. Removing the probe from the probe well, loading a probe cover, and holding the probe tip in place at the measurement site initiates a Predictive mode measurement. The monitor sounds a tone to indicate the end of a predictive measurement.

Direct mode

Provides continual temperature measurements. For oral and rectal measurements, it is recommended to measure temperature until the temperature stabilizes or for 3 minutes. For axillary measurements, it is recommended to measure temperature until the temperature stabilizes or for 5 minutes. The monitor changes to Direct mode approximately 60 seconds after the probe is removed from the probe well.

Note The monitor does not retain Direct mode temperatures in memory. Therefore, it is important to note the temperature before removing the probe from the measurement site and then manually record it in the patient record.

After 10 minutes of using the Direct mode, the monitor generates a technical alarm condition and clears the measurement.

Take a temperature in the Predictive mode



WARNING Inaccurate measurement risk. To ensure optimal accuracy, always confirm that the correct mode and site are selected.



WARNING Patient injury risk. Prior to taking a temperature, instruct the patient not to bite down on the probe as patient injury and damage to the probe may result.



CAUTION Probe covers are disposable, nonsterilized, and single-use. Probes are also nonsterilized. Do not autoclave probes and probe covers. Ensure that probe covers are disposed of according to facility requirements or local regulations.

1. Remove the temperature probe from the probe well.

The monitor sounds a tone as it enters the ready state.

2. Insert the probe into a new probe cover and press the probe handle down firmly.
3. Touch the **Temperature site control**  to choose from these measurement sites: oral, pediatric axillary, or adult axillary.
4. Hold the probe tip in place at the measurement site.

For oral temperatures, place the probe tip under the patient's tongue on either side of the mouth to reach the sublingual pocket and ask the patient to close his/her lips.

Note Do not hand the probe to patients to place in their mouth.

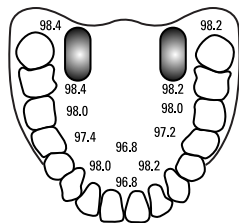

For axillary temperatures, lift the patient's arm so that the entire axilla is easily seen and place the probe tip as high as possible in the mid-axilla. Verify that axillary tissue completely surrounds the probe tip and place the arm snugly at the patient's side.

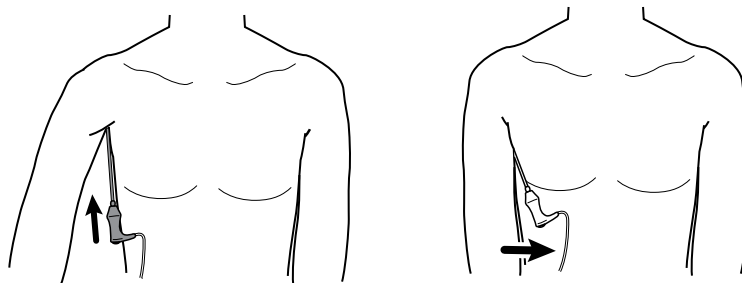

While the measurement is taking place, the temperature frame displays the process indicator.



5. The monitor sounds a tone when the final temperature is reached (in approximately 6 to 15 seconds). The temperature frame continues to display the temperature even after the probe is returned to the probe well.



Note To switch to the Direct mode, touch  after you acquire the Predictive mode measurement. The temperature frame displays text indicating that the Direct mode is active.

The monitor sounds a tone at the start of a Direct mode measurement.

6. Remove the probe after the temperature measurement is complete and firmly press the eject button on the top of the probe to release the probe cover.



WARNING Patient injury risk. Do not exceed the recommended temperature measurement durations in Direct mode. Continuous measurement durations of 3 minutes at the oral and rectal sites and 5 minutes at the axillary site are recommended for accurate measurement. Do not continuously measure beyond 10 minutes in any mode.

Ensure that probe covers are disposed of according to facility requirements or local regulations.

7. Return the probe to the probe well.
8. Wash your hands to reduce the risk of cross-contamination.

Take a temperature in the Direct mode

Direct mode displays the temperature of the probe as long as the probe tip remains in place at the measurement site and remains within the operating patient temperature range. The patient's temperature will reach final equilibrium in approximately 3 minutes at the oral and rectal measurement sites and approximately 5 minutes at the axillary site.

The monitor enters Direct mode by the following methods.

- After you complete a Predictive mode measurement, touch  to switch from Predictive to Direct mode. The temperature frame displays text indicating that the Direct mode is active.
- Remove the probe from the probe well, load a probe cover, select a temperature site, and expose the probe to ambient air for more than 60 seconds to switch the monitor to Direct mode. The temperature frame displays text indicating that the Direct mode is active.
- If you have a patient whose body temperature is below the normal temperature range and you follow the previous step, the probe sensor identifies this condition and turns off the probe preheater in order to accommodate the lower body temperature measurement.



WARNING Patient injury risk. Do not exceed the recommended temperature measurement durations in Direct mode. Continuous measurement durations of 3 minutes at the oral and rectal sites and 5 minutes at the axillary site are recommended for accurate measurement. Do not continuously measure beyond 10 minutes in any mode.



WARNING Inaccurate measurement risk. To ensure optimal accuracy, always confirm that the correct mode and site are selected.



WARNING Patient injury risk. Prior to taking a temperature, instruct the patient not to bite down on the probe as patient injury and damage to the probe may result.



CAUTION Probe covers are disposable, nonsterilized, and single-use. Probes are also nonsterilized. Do not autoclave probes and probe covers. Ensure that probe covers are disposed of according to facility requirements or local regulations.

1. Remove the temperature probe from the probe well.
The monitor sounds a tone as it enters the ready state.
2. Insert the probe into a new probe cover and press the probe handle down firmly.
3. Touch the **Temperature site control**  to choose from these measurement sites: oral, pediatric axillary, or adult axillary.

The temperature frame changes to Direct mode approximately 60 seconds after the probe is removed from the probe well.

The monitor sounds a tone to indicate the start of a Direct mode measurement.

4. Hold the probe tip in place at the oral or rectal measurement site for a total of 3 minutes and for 5 minutes at the axillary site.
5. While the measurements are taking place, the temperature frame displays the patient's continuous temperature measurements.



Note The monitor does not retain Direct mode temperatures in memory. Therefore, it is important to note the temperature before removing the probe from the measurement site and then manually record it in the patient record.

6. Remove the probe after the temperature measurement is complete and firmly press the eject button on the top of the probe to release the probe cover.
7. Return the probe to the probe well to continue taking temperatures in the Predictive mode.
8. Wash your hands to reduce the risk of cross-contamination.

Take a temperature at the rectal site



WARNING Patient injury risk. When taking rectal temperatures, insert the probe tip only 5/8 inch (approximately 1.5 cm) inside the rectum of adults and only 3/8 inch (approximately 1 cm) inside the rectum of children to avoid the risk of bowel perforation.



WARNING Cross-contamination or nosocomial infection risk. Thorough hand-washing greatly reduces the risk of cross-contamination and nosocomial infection.



WARNING Patient injury risk. Do not exceed the recommended temperature measurement durations in Direct mode. Continuous measurement durations of 3 minutes at the oral and rectal sites and 5 minutes at the axillary site are recommended for accurate measurement. Do not continuously measure beyond 10 minutes in any mode.



WARNING Inaccurate measurement risk. To ensure optimal accuracy, always confirm that the correct mode and site are selected.



CAUTION Probe covers are disposable, nonsterilized, and single-use. Probes are also nonsterilized. Do not autoclave probes and probe covers. Ensure that probe covers are disposed of according to facility requirements or local regulations.

1. Remove the rectal temperature probe from the rectal probe well.

The monitor sounds a tone as it enters the ready state. The Temperature Site Control defaults to the rectal site.



2. Insert the rectal probe into a new probe cover and press the probe handle down firmly.
3. Separate the patient's buttocks with one hand. Use the other hand to gently insert the probe tip only 5/8 inch (1.5 cm) inside the rectum of adults and only 3/8 inch (approximately 1 cm) inside the rectum of children. The use of a lubricant is optional.
4. Insert the probe so that the tip is in contact with tissue. Continue to separate the buttocks and hold the probe in place throughout the measurement process. While the measurement is taking place, the temperature frame displays the process indicator.



5. The monitor sounds a tone when the final temperature is reached (in approximately 10 to 13 seconds). The temperature frame continues to display the temperature even after the probe is returned to the probe well.



Note

To switch to the Direct mode, touch  after the

Predictive mode measurement is acquired. The temperature frame displays text indicating that the Direct mode is active. The monitor sounds a tone to indicate the start of a Direct measurement. Once you are in the Direct mode, continue to separate the buttocks and hold the probe in place throughout the measurement process.

Note The monitor does not retain Direct mode temperatures in memory. Therefore, it is important to note the temperature before removing the probe from the measurement site and then manually record it in the patient record.

6. Remove the probe after the temperature measurement is complete and firmly press the eject button on the top of the probe to release the probe cover.
7. Return the probe to the probe well.
8. Wash your hands to reduce the risk of cross-contamination.

Braun ThermoScan® PRO 4000 thermometer and accessory dock

The thermometer and accessory dock enable you to transfer an ear temperature measurement to the monitor. The dock also charges the thermometer battery.

Read the thermometer manufacturer's directions for use before attempting to configure, use, troubleshoot, or maintain the thermometer.



WARNING Liquids can damage electronics inside the thermometer. Prevent liquids from spilling on the thermometer. If liquids are spilled on the thermometer, dry off the thermometer with a clean cloth. Check for proper operation and accuracy. If liquids possibly entered the thermometer, remove the thermometer from use until it has been properly dried, inspected, and tested by qualified service personnel.



CAUTION Probe covers are disposable, nonsterilized, and single-use. The thermometer is also nonsterilized. Do not autoclave the thermometer and probe covers. Ensure that probe covers are disposed of according to facility requirements or local regulations.



CAUTION The thermometer has no user-serviceable parts. If service is required, call your nearest Welch Allyn Customer Service or Technical Support facility.



CAUTION Store the thermometer and probe covers in a dry location, free from dust and contamination and away from direct sunlight. Keep the ambient temperature at the storage location fairly constant and within the range of 50°F to 104°F (10°C to 40°C).

Take a temperature at the ear site



WARNING Probe covers are single-use only. Re-use of a probe cover may result in spread of bacteria and cross-contamination.



WARNING Inaccurate measurement risk. Use only Braun ThermoScan probe covers with this thermometer.



WARNING Inaccurate measurement risk. Frequently inspect the probe window and keep it clean, dry, and undamaged. Fingerprints, cerumen, dust, and other contaminants reduce the transparency of the window and result in lower temperature measurements. To protect the window, always keep the thermometer in the accessory dock when the thermometer is not in use.



CAUTION Inaccurate measurement risk. Before taking a temperature measurement, make sure that the ear is free from obstructions and excess cerumen build-up.



CAUTION Inaccurate measurement risk. The following factors can affect ear temperature measurements for up to 20 minutes:

- The patient was lying on his or her ear.
- The patient's ear was covered.
- The patient was exposed to very hot or very cold temperatures.
- The patient was swimming or bathing.
- The patient was wearing a hearing aid or an ear plug.



CAUTION Inaccurate measurement risk. If ear drops or other ear medications have been placed in one ear canal, take the temperature in the untreated ear.

Note A temperature measurement taken in the right ear might differ from a measurement taken in the left ear. Therefore, always take the temperature in the same ear.

Note When the monitor receives an ear temperature measurement, it displays the measurement on the Home tab. If the Home tab already contains a temperature measurement, the new measurement overwrites it.

To take a measurement and transfer it to the monitor:

1. Make sure that the monitor is powered on.
2. Remove the ear thermometer from the accessory dock.
3. Locate the probe cover box in the accessory dock.
4. Firmly push the probe tip into the probe cover box.

When the probe cover is in place, the thermometer turns on automatically.

5. Wait for the ready beep and three dashes to appear on the thermometer display.
6. Fit the probe snugly into the ear canal and then push and release the **Start** button.
 - If the probe is positioned correctly in the ear canal the ExacTemp light flashes. When the thermometer detects an accurate measurement, the ExacTemp light is continuously on, a long beep signals the end of the measurement, and the display shows the result.
 - If the probe is positioned incorrectly in the ear canal or is moved during the measuring process, the ExacTemp light goes out, a sequence of short beeps sounds, and the error message POS (position error) appears.
7. When you are finished taking the temperature, press the ejector button to eject the used probe cover.
8. Return the thermometer to the accessory dock.

The LED on the dock flashes while the measurement is being transferred.

After the transfer is complete, the temperature and the temperature scale appear on the Home tab according to the monitor settings.

Note Only the latest measurement is transferred to the monitor.

Note Measurements that have already been transferred to the monitor cannot be transferred again.

For more information about thermometer functionality, refer to the thermometer manufacturer's directions for use.

Change the temperature scale on the ear thermometer

To switch from Celsius to Fahrenheit, refer to the thermometer manufacturer's directions for use.

Charge the ear thermometer battery

To charge the battery pack:

- Place the thermometer in the accessory dock.
- Make sure that the monitor is connected to AC power.
- Make sure that the monitor is powered on.

The LED on the dock indicates the charging status of the battery pack:

- Orange: The battery pack is charging.
- Green: The battery pack is charged.
- Not illuminated: The battery pack is not charging.

Note The battery pack continues to charge while the monitor is in Display power saving mode.

Note It is strongly recommended that you use only the Welch Allyn rechargeable battery pack in the thermometer because the dock cannot charge other batteries.

Temperature mode selection

The monitor with the temperature module takes a patient temperature in either Predictive (Normal) or Direct mode. The default setting is the Predictive mode.



WARNING Inaccurate measurement risk. To ensure optimal accuracy, always confirm that the correct mode and site are selected.



WARNING Patient injury risk. Do not exceed the recommended temperature measurement durations in Direct mode. Continuous measurement durations of 3 minutes at the oral and rectal sites and 5 minutes at the axillary site are recommended for accurate measurement. Do not continuously measure beyond 10 minutes in any mode.

Predictive mode

Is a one-time measurement that takes a temperature in approximately 6 to 15 seconds. Removing the probe from the probe well, loading a probe cover, and holding the probe tip in place at the measurement site initiates a Predictive mode measurement. The monitor sounds a tone to indicate the end of a predictive measurement.

Direct mode

Provides continual temperature measurements. For oral and rectal measurements, it is recommended to measure temperature until the temperature stabilizes or for 3 minutes.

For axillary measurements, it is recommended to measure temperature until the temperature stabilizes or for 5 minutes. The monitor changes to Direct mode approximately 60 seconds after the probe is removed from the probe well.

Note The monitor does not retain Direct mode temperatures in memory. Therefore, it is important to note the temperature before removing the probe from the measurement site and then manually record it in the patient record.

After 10 minutes of using the Direct mode, the monitor generates a technical alarm condition and clears the measurement.

SpO2

SpO2 and pulse rate monitoring continuously measures saturation level of oxygen in hemoglobin as well as the pulse rate in a patient through a pulse oximeter.

SpO2 frame

The SpO2 frame displays data and controls used in pulse oximetry measurements.

The frame provides a numeric view and a waveform view of SpO2 data. You can toggle between views by touching the left side of the frame.

SpO2 numeric view

The numeric view indicates the SpO2 saturation percentage and the pulse amplitude. Features of this view differ based on the type of sensor enabled and the profile selected. The size of the SpO2 frame and displayed measurements varies based on your configuration.

Nellcor sensor

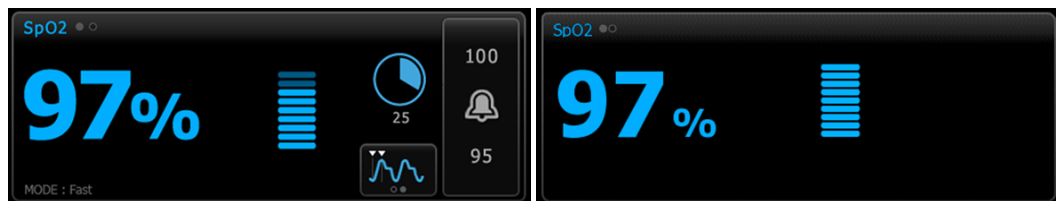

Intervals Monitoring and Continuous Monitoring profiles

Spot Check and Triage profiles

Masimo sensor

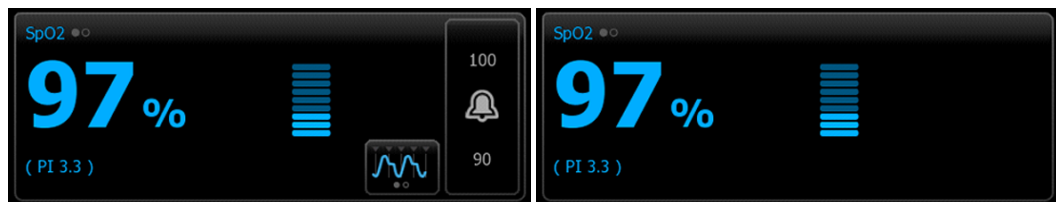

Intervals Monitoring profile, no SpHb license

Spot Check and Triage profiles

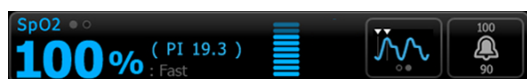

Intervals Monitoring profile, SpHb license activated

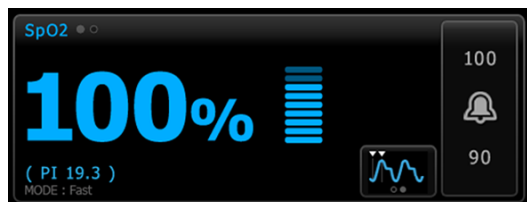

Continuous Monitoring profile

Pulse amplitude

The pulse amplitude bar indicates the pulse beat and shows the relative pulse strength. More bars illuminate as the detected pulse gets stronger.



Response Mode Control

The Response Mode Control allows you to set the SpO2 measurement time to either Normal or Fast.



Perfusion Index

Perfusion Index (PI) is an SpO2 feature available only with Masimo-equipped monitors.

PI is a relative reading of pulse strength at the monitoring site. PI display ranges from 0.1 percent (very weak pulse strength) to 20.0 percent (very strong pulse strength). PI is a relative number and varies between monitoring sites and from patient to patient, as physiological conditions vary.

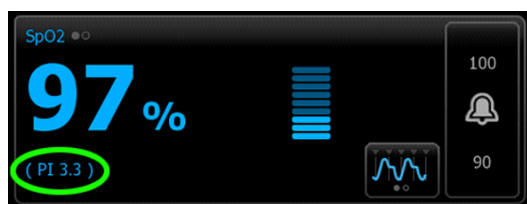

During sensor placement, the PI can be used to evaluate the appropriateness of an application site, looking for the site with the highest PI number. Placing the sensor at the site with the strongest pulse amplitude (highest PI number) improves performance during motion. Monitor the trend of the PI for changes in physiological conditions.

SatSeconds™ alarm management

The SatSeconds feature is an SpO2 alarm management system available only with monitors that are equipped with Nellcor OxiMax Technology.

The SatSeconds feature is the product of the time and magnitude that a patient falls outside of the SpO₂ alarm limits. For example, three points below the alarm limit for 10 seconds equals 30 SatSeconds. An alarm is triggered only when a desaturation event reaches the SatSeconds limit. The SatSeconds feature is clinician controlled and can be set to 0, 10, 25, 50, or 100 SatSeconds. If a desaturation event resolves on its own within the preset time, the clock will automatically reset and the monitor will not alarm.



Note The SatSeconds feature has a built-in safety protocol that sounds an alarm whenever three SpO₂ violations of any amount or duration occur within a 1-minute period.

SpO₂ waveform view

The waveform view shows the SpO₂ plethysmograph waveform. You can select the default SpO₂ waveform sweep speed in Advanced settings, but you can change the sweep speed on the Setup tab.

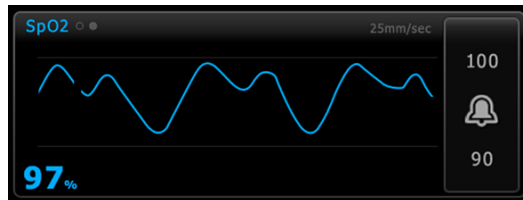

Set up SpO₂

Follow these steps to configure SpO₂ parameter settings and to set up modifiers.

1. Touch the **Settings** tab.
2. Touch the **Setup** tab.
3. Touch the **SpO₂** vertical tab.
4. Select the desired Sweep speed.
5. Touch the **Home** tab.

The new setting takes effect immediately.
6. To set up modifiers, touch the **Patients** tab.
7. Touch the **Manual** tab.
8. Scroll through the list to find the SpO₂ section, then enter or select the SpO₂ modifier(s) as desired.
 - SpO₂ measurement site. Select the measurement site from the list box.
 - O₂ flow rate. Enter the flow rate using the keypad.

Note All O₂ modifier selections are cleared when the O₂ flow rate is changed to 0 and when the O₂ method is changed to none.
 - O₂ concentration. Enter the concentration using the keypad.

- O2 Method. Select the method from the list box.
9. Enter or select other modifier(s), if applicable, as desired.
 10. Touch **OK**.

The Home tab appears. In the Continuous Monitoring profile, the modifiers are saved with the next set of measurements sent to the network. In the episodic profiles, the modifiers are saved with the next set of measurements you take or with any current, unsaved measurements on the device when you touch **Save**.

Configure SpO2 alarms

Follow these steps to set alarm limits for SpO2 measurements.

1. Verify that you are using the Intervals Monitoring or Continuous Monitoring profile.
2. Touch the **Alarms** tab.
3. Touch the **SpO2** vertical tab.
4. Ensure that the SpO2 alarm limit control is set to ON.

Note If any parameter's alarm limit control is set to OFF, you cannot adjust alarm limits on the Alarm tab, and no visual or audio signals will occur for that specific parameter.

5. Enter the desired upper and lower alarms limits for SpO2 using the up/down arrow keys or the keypad.

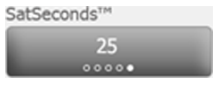
6. If your monitor is configured with a Nellcor SpO2 sensor, touch  to select a SatSeconds setting.
7. Touch the **Home** tab.

The new alarm settings take effect immediately.

Set Response Mode

To set the Response Mode from the Home tab, the monitor must be in the Intervals Monitoring or Continuous Monitoring profile.



Touch  in the SpO2 frame.

When Fast mode is selected, either **MODE: Fast** or **: Fast** appears in the frame.

Measure SpO2 and pulse rate



WARNING Inaccurate measurement risk. Use only Masimo rainbow SET sensors and accessories on Masimo-equipped monitors.



WARNING Inaccurate measurement risk. Use only Nellcor sensors and accessories on Nellcor-equipped monitors.



WARNING High-intensity lights (including pulsating strobe lights) directed on the pulse co-oximeter can prevent it from obtaining readings.



WARNING The pulsations from intra-aortic balloon support can increase the pulse rate displayed on the monitor. Verify the patient's pulse rate against the ECG heart rate.



WARNING Inaccurate measurement risk. Venous congestion might cause a low reading of arterial oxygen saturation. Place the sensor on a hand at heart level to ensure proper venous outflow from a monitored site.



WARNING Inaccurate measurement risk. The pulse co-oximeter can be used during defibrillation, but the reading may be inaccurate for up to 20 seconds.



WARNING Patient injury risk. Do not attempt to reprocess, recondition, or modify any sensors or patient cables. Doing so might damage electrical components.



WARNING Pulse rate measurement might not detect certain arrhythmias because it is based on the optical detection of a peripheral flow pulse. Do not use the pulse oximeter as a replacement or substitute for ECG-based arrhythmia analysis.



WARNING Use the pulse co-oximeter as an early warning device. As you observe a trend toward patient hypoxemia, use laboratory instruments to analyze blood samples to better understand the patient's condition.



WARNING The accuracy of SpO₂ measurements can be affected by any of the following:

- elevated levels of total bilirubin
- elevated levels of Methemoglobin (MetHb)
- elevated levels of Carboxyhemoglobin (COHb)
- hemoglobin synthesis disorders
- low perfusion at the monitored site
- the presence of concentrations of some intravascular dyes, sufficient to change the patient's usual arterial pigmentation
- patient movement
- patient conditions such as shivering and smoke inhalation
- motion artifact
- painted nails
- poor oxygen perfusion
- hypotension or hypertension
- severe vasoconstriction
- shock or cardiac arrest
- venous pulsations or sudden and significant changes in pulse rate
- proximity to an MRI environment
- moisture in the sensor
- excessive ambient light, especially fluorescent
- the use of the wrong sensor
- a sensor misapplied or dislodged
- severe anemia
- venous congestion

1. Verify that the sensor cable is connected to the monitor.



WARNING Patient injury risk. The sensor and extension cable are intended only for connection to pulse co-oximetry equipment. Do not attempt to connect these cables to a PC or any similar device. Always follow the sensor manufacturer's directions for care and use of the sensor.

2. Clean the application site. Remove anything, such as nail polish, that could interfere with sensor operation.

Note Do not use disposable sensors on patients who have allergic reactions to the adhesive.

3. Attach the sensor to the patient according to the manufacturer's directions for use, observing all warnings and cautions.



WARNING Patient injury and inaccurate measurement risk. Do not use tape to secure the sensor to the patient. This can restrict blood flow, damage the patient's skin, cause inaccurate readings, and damage the sensor.



WARNING Patient injury risk. Exercise caution when applying a sensor to a patient with compromised skin integrity. Applying tape or pressure to compromised sites can reduce circulation and cause additional skin damage.

Note If a sterile sensor is required, select a sensor that has been validated for sterilization, and follow the sensor manufacturer's directions for sterilizing the sensor.

Place the sensor and the NIBP cuff on different limbs to reduce unnecessary alarms when you monitor these parameters at the same time.

Note A range of sensors is available for different patient sizes and measurement sites. Consult the sensor manufacturer's instructions for selecting the correct sensor.

4. Confirm that the monitor displays SpO₂ and pulse rate data within 15 seconds of connection to the patient.



WARNING Patient injury risk. Incorrect sensor application or excessive duration of sensor use can cause tissue damage. Inspect the sensor site periodically as directed in the sensor manufacturer's instructions.

While SpO₂ is being measured, the displayed pulse rate is derived from the sensor. If SpO₂ is not available, the pulse rate is derived from NIBP.

If SpO₂ is being measured continuously on a patient for an extended period, change the sensor location at least every three hours or as indicated by the sensor manufacturer's instructions.

Note In the Intervals Monitoring and Continuous Monitoring profiles, removing the SpO₂ sensor from the patient triggers the following responses:

- The last SpO₂ saturation measurement captured before the sensor was removed remains on the display for approximately 10 seconds and then is cleared.
- If SpO₂ physiological alarm limits are ON, when the saturation measurement is cleared, a "Searching for pulse signal" technical alarm occurs.
- If SpO₂ physiological alarm limits are OFF, when the saturation measurement is cleared, no physiological or technical alarms occur.

SpHb

Monitors configured with Masimo total hemoglobin can measure hemoglobin (SpHb), SpO₂, and pulse rate. SpHb monitoring continuously measures blood constituents and anemic status in a patient through a noninvasive SpHb pulse co-oximeter.

SpHb frame

The SpHb frame displays data and controls used in total hemoglobin measurements.

Note SpHb is available only in the Intervals Monitoring and Continuous Monitoring profiles.

In this frame, one of two labels appears:

- **SpHbv** indicates the venous calibrated reference for total hemoglobin measurement.
- **SpHb** indicates the arterial calibrated reference for total hemoglobin measurement.

You can specify the reference source in Advanced settings.

The frame provides a numeric view and a graphical trend view of total hemoglobin data. You can toggle between views by touching the left side of the frame.

SpHb numeric view

The numeric view indicates the total hemoglobin level in either grams per deciliter (g/dL) or millimoles per liter (mmol/L). You can select the unit of measure in Advanced settings. The size of the SpHb frame and displayed measurements varies based on your configuration.



Averaging

The averaging button enables you to select the moving window of time used by the parameter to calculate the SpHb value and update the display: short (approximately 1 minute), medium (approximately 3 minutes), or long (approximately 6 minutes).



SpHb graphical trend view

The graphical trend view presents a trend of the measurements over a user-selected period. You can select the period displayed on the Setup tab. The size of the SpHb frame and displayed trend varies based on your configuration.



The graph shows total hemoglobin level on the y-axis and time on the x-axis (oldest measurements on the left to newest measurements on the right). The entire graph updates every 10 seconds.

To the right of the graph, the frame displays the current measurement in numeric format.

Set up SpHb

Follow these steps to configure SpHb parameter settings.

1. Touch the **Settings** tab.
2. Touch the **Setup** tab.
3. Touch the **SpHb** vertical tab.
4. Select the desired Trend period.
5. Touch the **Home** tab.

The new settings take effect immediately.

Configure SpHb alarms

Follow these steps to set alarm limits for SpHb measurements.

1. Verify that you are using the Intervals Monitoring or Continuous Monitoring profile.
2. Touch the **Alarms** tab.
3. Touch the **SpHb** vertical tab.
4. Ensure that the SpHb alarm limit control is set to ON.

Note If any parameter's alarm limit control is set to OFF, you cannot adjust alarm limits on the Alarm tab, and no visual or audio signals will occur for that specific parameter.

5. Enter the desired upper and lower alarm limits for SpHb using the up/down arrow keys or the keypad.
6. Touch the **Home** tab.

The new alarm settings take effect immediately.

Set SpHb averaging mode



Touch  in the SpHb frame.

The SpHb frame displays the current mode.

Measure SpHb



WARNING Inaccurate measurement risk. Use only Masimo rainbow SET sensors and accessories on Masimo-equipped monitors.



WARNING High-intensity lights (including pulsating strobe lights) directed on the pulse co-oximeter can prevent it from obtaining readings.



WARNING The pulsations from intra-aortic balloon support can increase the pulse rate displayed on the monitor. Verify the patient's pulse rate against the ECG heart rate.



WARNING Inaccurate measurement risk. Venous congestion might cause a low reading of arterial oxygen saturation. Place the sensor on a hand at heart level to ensure proper venous outflow from a monitored site.



WARNING Inaccurate measurement risk. The pulse co-oximeter can be used during defibrillation, but the reading may be inaccurate for up to 20 seconds.



WARNING Patient injury risk. Do not attempt to reprocess, recondition, or modify any sensors or patient cables. Doing so might damage electrical components.



WARNING Pulse rate measurement might not detect certain arrhythmias because it is based on the optical detection of a peripheral flow pulse. Do not use the pulse oximeter as a replacement or substitute for ECG-based arrhythmia analysis.



WARNING Use the pulse co-oximeter as an early warning device. As you observe a trend toward patient hypoxemia, use laboratory instruments to analyze blood samples to better understand the patient's condition.



WARNING The accuracy of SpHb measurements can be affected by any of the following:

- elevated levels of total bilirubin
- elevated levels of Methemoglobin (MetHb)
- elevated levels of Carboxyhemoglobin (COHb)
- hemoglobin synthesis disorders
- low perfusion at the monitored site
- the presence of concentrations of some intravascular dyes, sufficient to change the patient's usual arterial pigmentation
- patient movement
- patient conditions such as shivering and smoke inhalation
- motion artifact
- painted nails
- poor oxygen perfusion
- hypotension or hypertension
- severe vasoconstriction
- shock or cardiac arrest
- venous pulsations or sudden and significant changes in pulse rate
- proximity to an MRI environment
- moisture in the sensor
- excessive ambient light, especially fluorescent
- the use of the wrong sensor
- a sensor misapplied or dislodged
- severe anemia
- venous congestion

1. Verify that the sensor cable is connected to the monitor.



WARNING Patient injury risk. The sensor and extension cable are intended only for connection to pulse co-oximetry equipment. Do not attempt to connect these cables to a PC or any similar device. Always follow the sensor manufacturer's directions for care and use of the sensor.

2. Verify that you are using the Continuous or Intervals profile.
3. Clean the application site. Remove anything, such as nail polish, that could interfere with sensor operation.

Note Do not use disposable sensors on patients who have allergic reactions to the adhesive.

4. Attach the sensor to the patient according to the manufacturer's directions for use, observing all warnings and cautions.



WARNING Patient injury and inaccurate measurement risk. Do not use tape to secure the sensor to the patient. This can restrict blood flow, damage the patient's skin, cause inaccurate readings, and damage the sensor.



WARNING Patient injury risk. Exercise caution when applying a sensor to a patient with compromised skin integrity. Applying tape or pressure to compromised sites can reduce circulation and cause additional skin damage.

Note If a sterile sensor is required, select a sensor that has been validated for sterilization, and follow the sensor manufacturer's directions for sterilizing the sensor.

Place the sensor and the NIBP cuff on different limbs to reduce unnecessary alarms when you monitor these parameters at the same time.

Note A range of sensors is available for different patient sizes and measurement sites. Consult the sensor manufacturer's instructions for selecting the correct sensor.

5. Confirm that the monitor displays SpHb or SpHbv data after connection to the patient.



WARNING Patient injury risk. Incorrect sensor application or excessive duration of sensor use can cause tissue damage. Inspect the sensor site periodically as directed in the sensor manufacturer's instructions.

While SpHb is being measured, the displayed SpO2 and pulse rate are derived from the same sensor. If SpO2 is not available, the pulse rate is derived from NIBP.

Detaching the sensor during a measurement triggers an alarm.

If SpHb is being measured continuously on a patient for an extended period, change the sensor location at least every three hours or as indicated by the sensor manufacturer's instructions.

Pulse rate frame

The Pulse rate frame displays data, information, and controls used in reading pulse rates.

Pulse rate is derived from one of three sensors based on your configuration: the SpO2 sensor, the NIBP sensor, or the EarlySense sensor. The source of Pulse rate measurements appears in the lower left corner of the frame.



WARNING Inaccurate measurement risk. Pulse rate measurements generated through the blood pressure cuff or through SpO2 are subject to artifact and might not be as accurate as heart rate measurements generated through ECG or through manual palpation.

Note You can specify pulse tone volume in the Pulse rate vertical tab (located in the **Settings > Setup** tab).

Continuous Monitoring profile

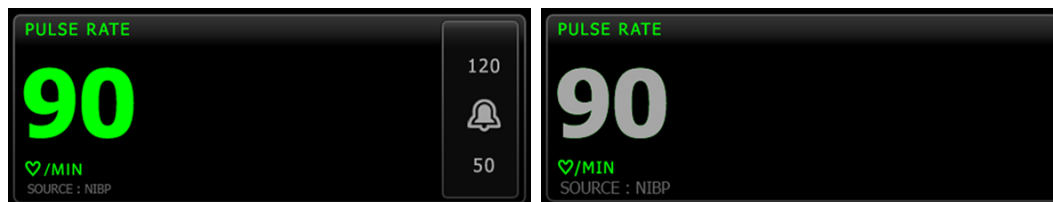

The size of the pulse rate frame and displayed measurements varies based on your configuration.

The Continuous Monitoring profile also provides a visual indication of aging episodic measurements (those more than 16 minutes old). When a pulse rate measurement derived from NIBP is displayed for more than 16 minutes, the numeric on the screen changes from its current color to gray. (See the timestamp in the NIBP frame for actual time of this measurement.) After one hour, this measurement is cleared from the frame.

Intervals Monitoring profile

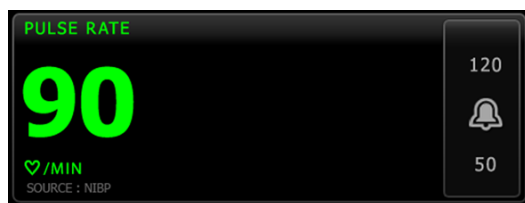

Spot Check and Triage profiles



Set up pulse rate

Follow these steps to configure pulse rate parameter settings.

1. Touch the **Settings** tab.
2. Touch the **Setup** tab.
3. Touch the **Pulse rate** vertical tab.
4. Select the desired Tone volume.
5. Touch the **Home** tab.

The new settings take effect immediately.

Configure pulse rate alarms

Follow these steps to set alarm limits for pulse rate.

1. Verify that you are using the Intervals Monitoring or Continuous Monitoring profile.
2. Touch the **Alarms** tab.
3. Touch the **Pulse rate** vertical tab.
4. Ensure that the Pulse rate alarm limit control is set to ON.

Note If any parameter's alarm limit control is set to OFF, you cannot adjust alarm limits on the Alarm tab, and no visual or audio signals will occur for that specific parameter.

5. Enter the desired upper and lower alarm limits for pulse rate using the up/down arrow keys or the keypad.
6. Touch the **Home** tab.

The new alarm settings take effect immediately.

Manual parameters frame

The Manual parameters frame, located in the lower right of the Home tab, supports manual entry of parameters and displays measurements taken by some accessories.

Note Manual parameters are not available in the Triage profile.

Note Body mass index (BMI) is only available with an attached weight scale that calculates BMI.

Note When a measurement is transferred from an attached weight scale to the device, the measurement displayed on the device is within one decimal place (0.1) of the measurement displayed by the weight scale.

Note You cannot manually enter temperature in this frame on a device configured with a SureTemp Plus temperature module.

Note You cannot manually enter respiration rate in this frame on a device configured with CO₂, RRa, or EarlySense.

Enter manual parameters

Note The Manual parameters frame enables you to enter measurements taken manually and displays measurements taken by some accessories. You can select and configure the parameters in Advanced settings. Only four parameters appear in the Manual parameters frame.



CAUTION Weight scales attached to this monitor must be running on battery power (battery type is specified in the weight scale manufacturer's directions for use). Do not use the weight scale's external power supply.

1. From the Home tab, touch anywhere within the Manual parameters frame.

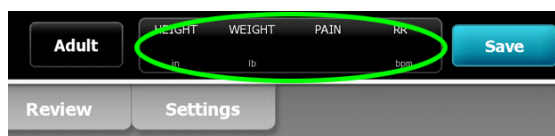

The Manual tab appears.

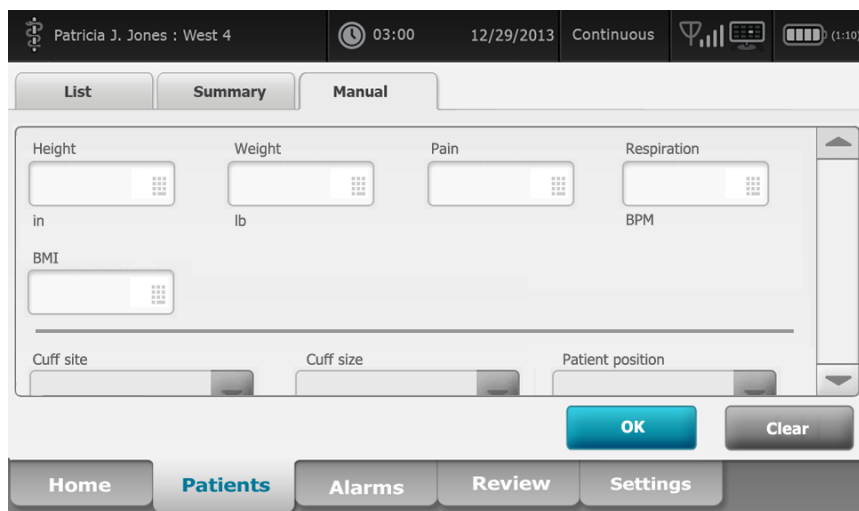

2. Touch the keypad icon in selected fields to open the numeric keypad, and then manually adjust height, weight, pain level, temperature, respiration rate, or other parameters.

Note If an approved, battery-powered weight scale is attached to the monitor, measurements from the weight scale populate fields in the Manual tab. You can adjust weight and height measurements on this tab, but if you do, the read-only BMI field will clear.

Note Ensure that the current patient ID is correct before saving.

3. Touch **OK** to confirm settings and return to the Home tab.

Note In the Intervals Monitoring and Spot Check (episodic) profiles, manual parameters clear from the Home tab after a successful save.

Note When the device is connected to a central station and in the Continuous Monitoring profile, all manual parameters except temperature will be sent to the central station when you touch **OK**.

Physical assessment instrument handles

Use the physical assessment instrument handles

The handles supply power to Welch Allyn 3.5V instruments. This section focuses on operation of the handles only. Refer to the directions for use for each instrument head to use it properly.

Note Handle modules are available only in the 84- and 85-series models.

Ensure the wall system is plugged in.

1. Lift the handle you want to use from the handle cradle.

The instrument will automatically power on when you remove it from the handle cradle. Only one handle is powered at a time.

2. Attach a specula to the end of the instrument head if appropriate.
3. Adjust light output by turning the rheostat on the handle.
 - Turning the rheostat clockwise increases the light output.

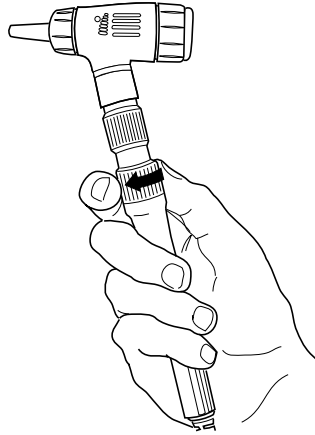

- Turning the rheostat counterclockwise decreases the light output.

Note The rheostat does not power down the instrument when you turn it counterclockwise as far as it will go.

4. Follow the directions for use for the instrument head when examining a patient.



CAUTION Do not overstretch the cords on these handles to prevent damage. Always examine patients within a comfortable reach of the wall system to protect the cords.



CAUTION To minimize the external housing temperature of the diagnostic instrument heads, on-time should not exceed 2 minutes, and off-time should be a minimum of 10 minutes.

5. Return the handle to the handle cradle.

Placing the handle in the cradle disengages the OptiSense™ optical sensor and powers down the instrument.

Note The handles continue to receive power as long as the wall system is plugged in, has a charged and functioning battery, and is powered on. You can power down the handles by powering down the entire wall system. See the Startup section for details.

Maintenance and service

Vital Signs Monitor 6000 Series

Perform periodic checks

Welch Allyn recommends that each facility conduct periodic checks of each monitor.

1. Check the following at least daily:
 - Audible indicators (a piezo beeper and a speaker tone) at power-up
 - Fan, especially at startup
 - Touchscreen alignment
 - Date
 - Time
2. Visually inspect the following at least weekly:
 - The monitor for any damage or contamination
 - The AC cord for exposed copper
 - All cables, cords, and connector ends for damage or contamination
 - All mechanical parts, including covers, for integrity
 - All safety-related labeling for legibility and adhesion to the monitor
 - All accessories (cuffs, tubing, probes, sensors) for wear or damage
 - Documentation for current revision of the monitor
3. Do the following at least monthly:
 - Test the speaker by selecting each alarm volume level and listening for the different tones
 - Visually inspect the mobile stand wheels for wear and faulty operation
 - Visually inspect the mounting screws on the wall or cart for looseness and wear

Update settings, replace items, or call for service as necessary based on results of visual inspection. Do not use the monitor if you see any signs of damage. Qualified service personnel must check any monitor that is damaged for proper operation before putting the monitor back into use.

Replace the printer paper

The printer is located on the top of the monitor. Follow these steps to replace the roll of printer paper:

1. Grasp the two tabs and pull up to open the printer door.
2. Remove the empty core.



WARNING Hot surface. Do not touch the printer mechanism.

3. Insert a new roll of paper.

Note The paper roll must be installed so that it unwinds from the bottom of the roll, as illustrated. If the paper roll is not installed correctly, the printer will not print properly.

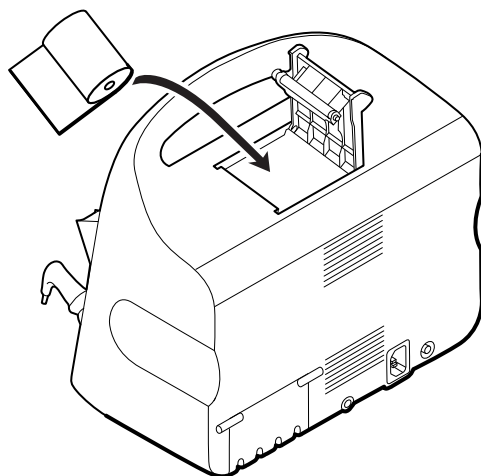

4. Advance the end of the roll past the roller so that it extends past the printer door, as shown.

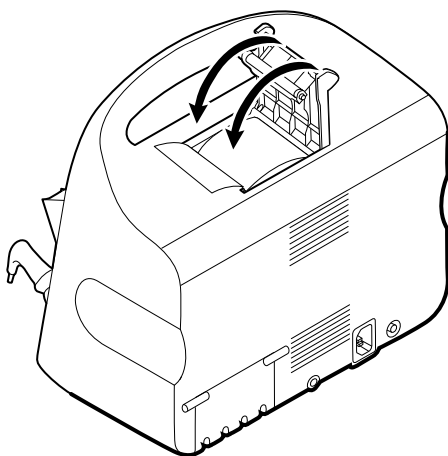

5. With one hand, pull lightly on the paper to take up any slack. With the other hand, close the printer door by pushing it down and into place until it clicks.

Be certain that the paper does not catch in the printer door.

Change the battery

Before removing the battery, shut down the monitor.

1. Turn the monitor upside down to access the battery cover.
2. Locate the battery cover, indicated by .
3. Insert a coin into the slot and push to open. Choose a coin that fits comfortably in the slot.

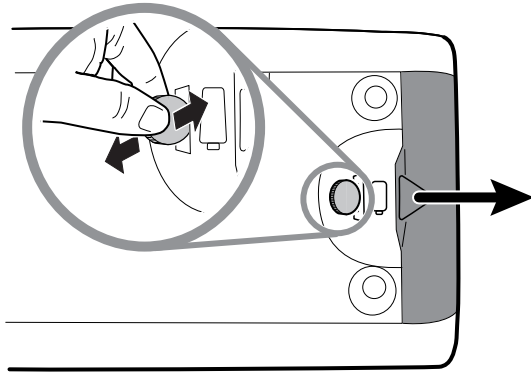

4. Pull the battery out by pulling the battery label, which is visible when you open the battery cover.

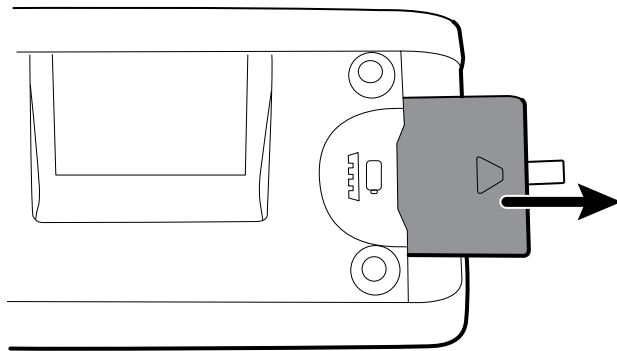

5. Slide in the new battery. Ensure that you insert the new battery in the same orientation as the old battery.

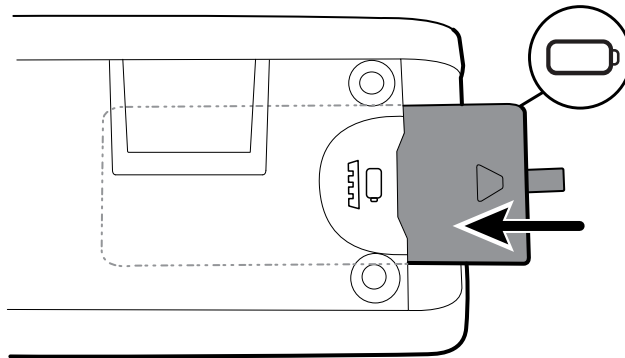

6. Replace the battery cover by positioning the end below  and then pressing firmly on the opposite end.

Note New batteries are only 30 percent charged. Therefore, connect the monitor to AC power immediately after inserting a new battery.



WARNING Risk of fire, explosion, and burns. Do not short-circuit, crush, incinerate, or disassemble the battery pack. Never dispose of batteries in refuse containers. Always recycle batteries according to local regulations.

Clean the monitor



WARNING Electric shock hazard. Before cleaning the monitor, disconnect the AC power cord from the power outlet and the monitor.



WARNING Electric shock hazard. DO NOT autoclave the monitor or accessories. The monitor and the accessories are not heat-resistant.



WARNING Liquids can damage electronics inside the monitor. Prevent liquids from spilling on the monitor.

If liquids are spilled on the monitor:

1. Power down the monitor.
2. Disconnect the power plug.
3. Remove battery pack from the monitor.
4. Dry off excess liquid from the monitor.

Note If liquids possibly entered the monitor, remove the monitor from use until it has been properly dried, inspected, and tested by qualified service personnel.

5. Reinstall battery pack.
6. Power on the monitor and verify monitor functions normally before using it.

If liquids enter the printer housing:

1. Power down the monitor.
2. Disconnect the power plug.
3. Remove battery pack from the monitor.
4. Remove and discard the paper roll.
5. Clean and dry the inside of the printer housing.

Note The printer housing has a drain tube that directs liquids down and out the bottom of the device. If liquids possibly entered other openings in the monitor, remove the monitor from service until it has been properly dried, inspected, and tested by qualified service personnel.

6. Install a new roll of paper.
7. Power on the monitor and verify that the monitor functions normally before using it.

Clean on a routine basis according to your facility's protocols and standards or local regulations. If the monitor is on, lock the display and disconnect the AC power cord.

The following agents are compatible with the monitor:

- 70 percent isopropyl alcohol
- 10 percent chlorine bleach solution



CAUTION When cleaning the device, avoid using cloths or solutions that include quaternary ammonium compounds (ammonium chlorides) or glutaraldehyde-based disinfectants.

Note Disinfect according to your facility's protocols and standards or local regulations.

Avoid residual film buildup on the monitor by periodically cleaning the monitor with either of the cleaning solutions listed and wiping the monitor dry.

70 percent isopropyl alcohol

Wipe the monitor with a clean cloth slightly dampened with 70 percent isopropyl alcohol.

10 percent chlorine bleach solution

1. Wipe the monitor with a clean cloth slightly dampened with a 10 percent bleach and water solution. Follow the cleaning agent manufacturer's guidelines.
2. Rinse with a clean cloth slightly dampened with water that meets EP and USP quality standards.
3. Allow the monitor surface to dry for a minimum of 10 minutes before using the monitor.

Clean the accessories

1. Wipe the NIBP hose and any reusable cuffs with a damp cloth moistened in a mild detergent solution.
2. Wipe the temperature probe with a cloth dampened with alcohol, warm water, or an appropriately diluted, nonstaining disinfectant solution.
3. Clean the pulse oximetry sensors with a cloth dampened with 70 percent isopropyl alcohol or 10 percent chlorine bleach solution.
4. Clean the RRa cable and the SpO2/RRa dual cable with a cloth dampened with 70 percent isopropyl alcohol.
5. Clean the ear thermometer according to the manufacturer's directions for use.
6. Clean the ear thermometer dock with the same cleaning agents used on the monitor.
7. Clean the EarlySense sensor by gently wiping with a soft, slightly damp cloth or wipes containing antiseptic substances (alcohols, Chlorohexidine, and bleach material up to 5% concentration). Ensure that the sensor is dry before re-use. Avoid excessive liquids.



CAUTION Never immerse any monitor accessories.

Clean the stand

The same cleaning agents used on the monitor can be used on the stand and accessory cable management system. Clean on a routine basis according to your facility's protocols and standards, or local regulations.

Note Disinfect according to your facility's protocols and standards, or local regulations.

Integrated Wall System

Perform periodic checks

Welch Allyn recommends that each facility conduct periodic checks of each monitor.

1. Check the following at least daily:
 - Audio (speaker and piezo beeper tones), especially at startup
 - Fan, especially at startup
 - Touchscreen alignment
 - Date
 - Time
2. Visually inspect the following at least weekly:
 - the monitor for any damage or contamination
 - all cables, cords, and connector ends for damage or contamination
 - all mechanical parts, including covers, for integrity
 - all safety-related labeling for legibility and adhesion to the monitor
 - all accessories (cuffs, tubing, probes, sensors) for wear or damage
 - documentation for current revision of the monitor
3. Visually inspect the following at least monthly:
 - Mounting screws on wall for looseness and wear

Update settings, replace items, or call for service as necessary based on results of visual inspection. Do not use the monitor if you see any signs of damage. Qualified service personnel must check any monitor that is damaged for proper operation before putting the monitor back into use.



CAUTION Wall system components shall be replaced by Welch Allyn service centers or qualified service personnel.

Remove the wall system from the wall

For maintenance or service activities that require access to the back of the wall system, follow these steps to remove the wall system from the wall.

1. Touch the **Settings** tab.
2. Touch the **Device** tab.
3. Touch **Power down**.
4. Remove all instrument heads, detach all accessible cords and cables, and unplug the power cord from the outlet.
5. Remove the cover by loosening the captive retention screws.

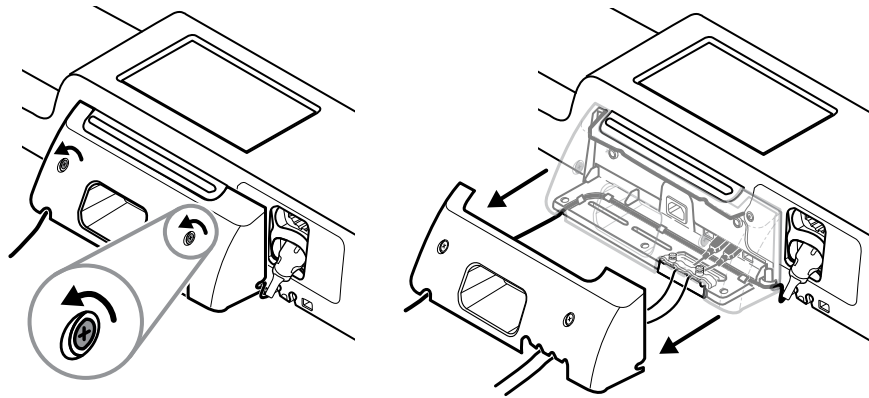

6. If USB accessories are connected, loosen the two screws on the cable retention clamp and remove it, then disconnect all USB cables.

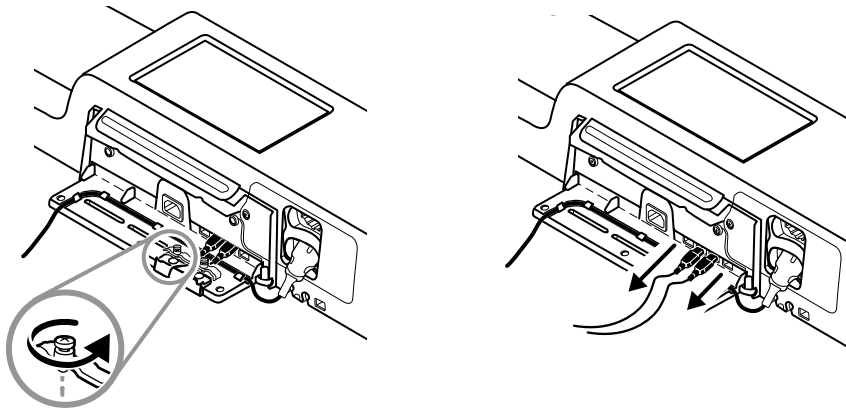

7. If the wall system is configured with SpO2, disconnect the SpO2 cable and remove it from the channel on the bottom of the wall system.

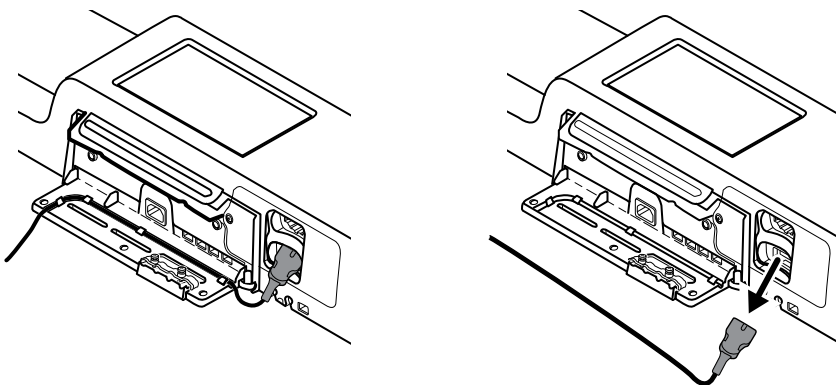

8. Remove the security screw at the bottom of the wall system.

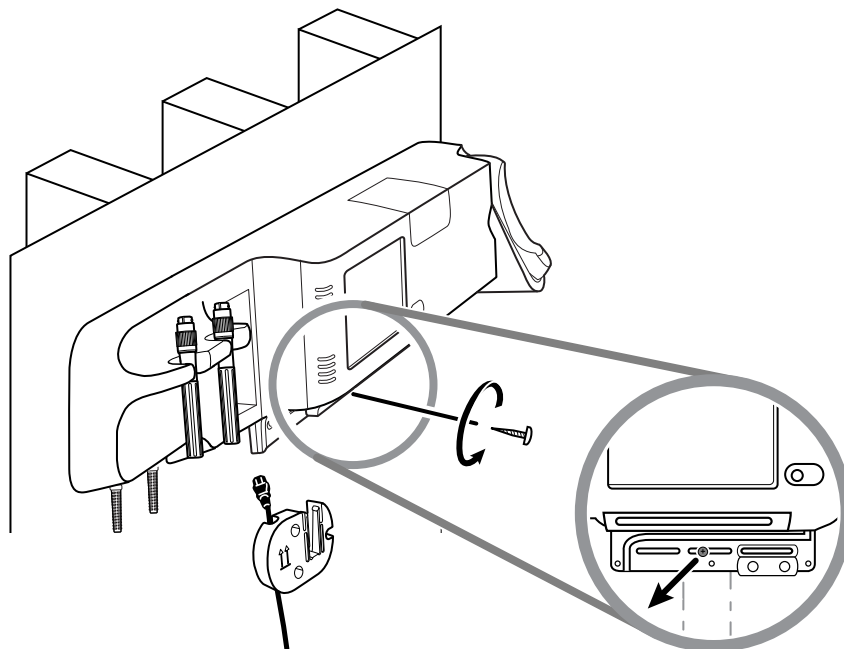

9. Carefully lift the wall system off the mounting rail bracket and place it onto a table or flat work surface.

Change the battery

Before removing the battery, follow the instructions to remove the wall system from the wall.

1. Place the wall system on a table or flat work surface so that the back of the wall system faces up.
2. Locate the battery, indicated by .
3. Remove the battery.
4. Insert the new battery. Ensure that you insert the new battery in the same orientation as the old battery.
5. Mount the wall system on the wall using the instructions presented in the Setup section of this directions for use.



WARNING Risk of fire, explosion, and burns. Do not short-circuit, crush, incinerate, or disassemble the battery pack. Never dispose of batteries in refuse containers. Always recycle batteries according to local regulations.

Note

New batteries are approximately 30 percent charged. Therefore, connect the battery to AC power immediately after inserting a new a battery.

Clean the wall system (excluding handle cradles and accessories)



WARNING Electric shock hazard. Before cleaning the wall system, disconnect the AC power cord from the power outlet.



WARNING Electric shock hazard. DO NOT autoclave the wall system or accessories. The wall system and the accessories are not heat-resistant.



WARNING Liquids can damage electronics inside the wall system. Prevent liquids from spilling on or dripping into the wall system. If liquids are spilled on or drip into the wall system:

1. Power down the wall system.
2. Disconnect the power plug.
3. Remove the wall system from the wall.
4. Remove battery pack from the wall system.
5. Dry off excess liquid from the wall system.

Note

If liquids possibly entered the wall system, remove the wall system from use until it has been properly dried, inspected, and tested by qualified service personnel.

6. Reinstall battery pack.
7. Mount the wall system on the wall. (See the Setup section of this directions for use.)
8. Power on the wall system and verify that the wall system functions normally before using it.

Clean on a routine basis according to your facility's protocols and standards or local regulations. If the monitor is on, lock the display and disconnect the AC power cord.

The following agents are compatible with the wall system:

- 70 percent isopropyl alcohol
- 10 percent chlorine bleach solution



CAUTION Some components and accessories of the wall system require special care during cleaning. To ensure optimal functioning and availability of specific components and accessories, use only the cleaning agents noted and the processes described for these items presented later in this section.

Note

Disinfect according to your facility's protocols and standards or local regulations.

70 percent isopropyl alcohol

Wipe the monitor with a clean cloth slightly dampened with 70 percent isopropyl alcohol.

10 percent chlorine bleach solution

1. Wipe the monitor with a clean cloth slightly dampened with a 10 percent bleach and water solution. Follow the cleaning agent manufacturer's guidelines.
2. Rinse with a clean cloth slightly dampened with water that meets EP and USP quality standards.
3. Allow the monitor surface to dry for a minimum of 10 minutes before using the monitor.

Clean the handle cradles

The blue handle cradles in the wall system require special attention.

Clean the handle cradles on a routine basis according to your facility's protocols and standards or local regulations.

The following agents are compatible with the handle cradles:

- 70 percent isopropyl alcohol
- 10 percent chlorine bleach solution

Note Disinfect according to your facility's protocols and standards or local regulations.

Clean the wall system accessories

The cleaning procedures for wall system accessories vary from the procedure to clean the wall system itself.

1. Wipe the NIBP hose and any reusable cuffs with a damp cloth moistened in a mild detergent solution.
2. Wipe the temperature probe with a cloth dampened with alcohol, warm water, or an appropriately diluted, nonstaining disinfectant solution.
3. Clean the pulse oximetry sensors with a cloth dampened with 70 percent isopropyl alcohol or 10 percent chlorine bleach solution.



CAUTION Never immerse any wall system accessories.

4. Clean the ear thermometer according to the manufacturer's directions for use.
5. Clean the physical assessment instrument handles and cords using the same cleaning agents used on the wall system. Clean on a routine basis according to your facility's protocols and standards, or local regulations.
6. To clean Welch Allyn 3.5V instrument heads attached to the physical assessment handles, follow instructions provided in their directions for use.

Advanced settings

The Advanced tab provides password-protected access to the monitor's Advanced settings (or Admin mode), enabling nurse administrators, biomedical engineers, and/or service engineers to configure specific features. The Advanced tab also presents read-only information about the monitor.

Note You cannot enter the Advanced settings if sensors or physiological alarms are active or if vital sign measurements are displayed.

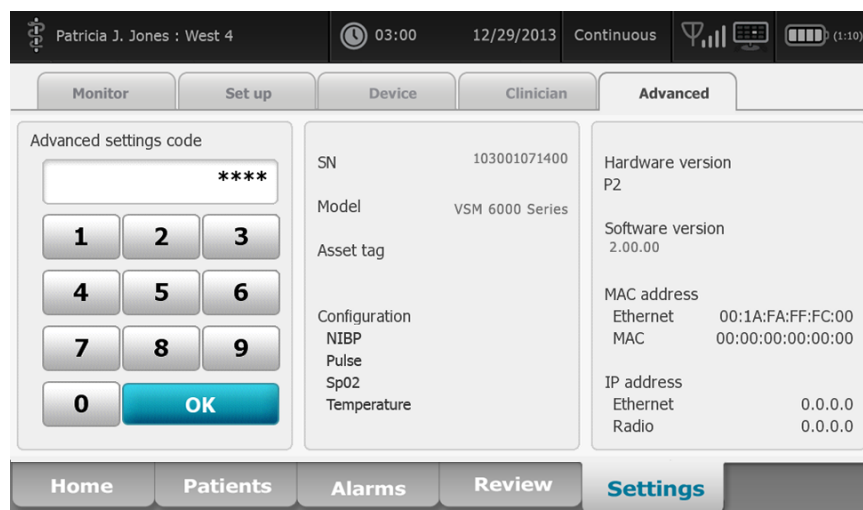

General

Specify the language

1. Access the Advanced Settings.
 - a. Touch the **Settings** tab.
 - b. Touch the **Advanced** tab.
 - c. Enter the **Advanced settings code**.
 - d. Touch **OK**.

The General tab appears, displaying the Language tab.
2. Select a language.
3. Do one of the following:
 - To continue in the Advanced Settings, touch another tab.

- To exit the Advanced Settings and return to the Home tab, touch **Exit**.

Specify date and time settings

1. Access the Advanced Settings.
 - a. Touch the **Settings** tab.
 - b. Touch the **Advanced** tab.
 - c. Enter the **Advanced settings code**.
 - d. Touch **OK**.

The General tab appears.
2. On the General tab, touch the **Date / Time** tab.
3. Specify settings.

Setting	Action/Description
Date format	Select a date format for display.
Time zone	Select your time zone offset from Coordinated Universal Time (UTC).
Automatically adjust clock for daylight saving time, reported by host	Select this to adjust the displayed time by +/- one hour when the connected host reports daylight savings time.
Allow users to change date and time	Select this to allow clinicians to set the date and time from the Settings tab.
Display date and time	Select this to display the date and time on the Home tab in the Device Status area.

4. Do one of the following:
 - To continue in the Advanced Settings, touch another tab.
 - To exit the Advanced Settings and return to the Home tab, touch **Exit**.

Specify advanced alarm settings

1. Access the Advanced Settings.
 - a. Touch the **Settings** tab.
 - b. Touch the **Advanced** tab.
 - c. Enter the **Advanced settings code**.
 - d. Touch **OK**.

The General tab appears.
2. Touch the **Alarms** tab.
3. Specify settings.

Option	Description
General	(vertical tab)
Allow user to disable alarms	Select to allow clinicians to turn off or turn on all alarm limits for each vital sign. The control is on each parameter-specific tab on the Alarms tab.
Nurse call threshold	Select the minimum priority alarm that activates a nurse call relay. If you select High , only high-priority alarms activate a nurse call relay. If you select Medium , medium- or high- priority alarms activate a nurse call

Audio

Allow user to turn off general audio

relay. If you select **Low**, high-, medium-, and low-priority alarms activate a nurse call relay.

(vertical tab)

Select to allow clinicians to turn off all audio notification for alarms. This control is on the Alarms tab (on the General tab).

Minimum alarm volume

Select the minimum alarm volume available. If you select **High**, then **Medium** and **Low** are not available to the clinician.

Audio pause time

Specify the amount of pause time that is added to the 60-second pause time. When a clinician pauses an audio alarm tone, the tone is paused for the combined amount of time.

Delays

(vertical tab)

Note Alarm delays are available only for the parameters supported by your configuration.

SpO2 alarm condition delay

Specify the minimum amount of time that an SpO2 alarm condition must be active before audio and visual signals occur.

SatSeconds is available with Nellcor SpO2 sensors. If you select Off or 10 seconds, SatSeconds is disabled, and it is removed from the SpO2 tab in the Alarms tab.

SpO2 pulse rate alarm condition delay

Specify the minimum amount of time that a Pulse rate alarm condition measured by the SpO2 sensor must be active before audio and visual signals occur.

Motion pulse rate alarm condition delay

Specify the minimum amount of time that a Pulse rate alarm condition measured by the patient movement sensor must be active before audio and visual signals occur.

SpHb alarm condition delay

Specify the minimum amount of time that an SpHb alarm condition must be active before audio and visual signals occur.

Motion respiration alarm condition delay

Specify the minimum amount of time that a respiration alarm condition must be active before audio and visual signals occur (EarlySense configuration).

Motion pulse rate low confidence alarm delay

Specify the minimum amount of time that a pulse rate low confidence alarm condition must be active before audio and visual signals occur (EarlySense configuration).

Motion respiration low confidence alarm delay

Specify the minimum amount of time that a respiration low confidence alarm condition must be active before audio and visual signals occur (EarlySense configuration).

etCO2 alarm condition delay

Specify the minimum amount of time that an etCO2 alarm condition must be active before audio and visual signals occur.

Respiration alarm condition delay

Specify the minimum amount of time that an RR alarm condition must be active before audio and visual signals occur.

No breath detected alarm delay

If configured with a CO2 module, specify the amount of time for the device to wait after receiving a "valid breath" message before activating the "No breath detected" physiological alarm.

If configured for RRa, specify the time that the Masimo module will wait before sending a respiration pause

event, which will result in a "No breath detected" physiological alarm.

4. Do one of the following:
 - To continue in the Advanced Settings, touch another tab.
 - To exit the Advanced Settings and return to the Home tab, touch **Exit**.

Specify advanced display settings

1. Access the Advanced Settings.
 - a. Touch the **Settings** tab.
 - b. Touch the **Advanced** tab.
 - c. Enter the **Advanced settings code**.
 - d. Touch **OK**.

The General tab appears.

2. Touch the **Display** tab.
3. Specify settings.

Setting

Display lock

Display power saver

Device power down

Action/Description

Specify the required period of clinician inactivity before the touchscreen locks.

Specify the required period of monitor inactivity before the display turns off.

Clinician interactions, new vital sign measurements, or alarm conditions automatically turn on the display.

Specify the required period of monitor inactivity before the monitor turns off.

4. Do one of the following:
 - To continue in the Advanced Settings, touch another tab.
 - To exit the Advanced Settings and return to the Home tab, touch **Exit**.

Specify advanced device settings

1. Access the Advanced Settings.
 - a. Touch the **Settings** tab.
 - b. Touch the **Advanced** tab.
 - c. Enter the **Advanced settings code**.
 - d. Touch **OK**.

The General tab appears.

2. Touch the **Device** tab.
3. Specify settings.

Option

Location ID

Enable Save as default

Description

Touch  and enter up to 20 alphanumeric characters.

Select to enable display of the Save as default control.

Pause Mode timeout	Specify the default timeout used when entering Pause mode in the Continuous Monitoring profile.
Power line frequency	Specify power line frequency for AC power supplied to the device.
Available profiles	Specify the profiles to be available for selection.
Allow profile change	Select to enable manual selection of different profiles and the automatic shift to the Continuous Monitoring profile when a continuous sensor is connected to a patient. When disabled, the current profile selection in the Settings tab is locked in. No other profile selection buttons are available, and the device does not automatically shift to the Continuous Monitoring profile when a continuous sensor is connected to a patient.
Default profile	Specify the default profile to be used at startup in the following Continuous Monitoring profile workflows: 1) patient trend data has not been saved, and 2) patient trend data has been saved and the user selects a new patient.

4. Do one of the following:
 - To continue in the Advanced Settings, touch another tab.
 - To exit the Advanced Settings and return to the Home tab, touch **Exit**.

Set and start the demo mode

1. Access the Advanced Settings.
 - a. Touch the **Settings** tab.
 - b. Touch the **Advanced** tab.
 - c. Enter the **Advanced settings code**.
 - d. Touch **OK**.

The General tab appears.

2. Touch the **General** tab.
3. Touch the **Demo** tab.
4. Specify settings.

Setting

Type

Start

Action/Description

Select a type of demonstration mode.

Touch **Start** to put the monitor in demonstration mode. Navigate to the Home tab to begin Demo mode.

5. Do one of the following:
 - To continue in the Advanced Settings, touch another tab.
 - To exit the Demo mode, touch **Exit** on the Home tab. The monitor restarts automatically.

Parameters

Specify advanced IPI settings

1. Access the Advanced Settings.
 - a. Touch the **Settings** tab.
 - b. Touch the **Advanced** tab.
 - c. Enter the **Advanced settings code**.
 - d. Touch **OK**.

The General tab will appear.

2. Touch the **Parameters** tab.
3. Touch the **IPI** tab.
4. Specify settings.

Setting

Display IPI

Default view

Trend period default

Action/Description

Select to display the IPI frame on the Home tab.

Select a numeric view or trend graph view as the primary IPI display on the Home tab.

Select a default time period for the trend graph display of IPI.

5. Do one of the following:
 - To continue in the Advanced Settings, touch another tab.
 - To exit the Advanced Settings and return to the Home tab, touch **Exit**.

Specify advanced RRa settings

1. Access the Advanced Settings.
 - a. Touch the **Settings** tab.
 - b. Touch the **Advanced** tab.
 - c. Enter the **Advanced settings code**.
 - d. Touch **OK**.

The General tab appears.

2. Touch the **Parameters** tab.
3. Touch the **RRa** tab.
4. Specify settings.

Setting

RRa averaging

Freshness timeout

Action/Description

Select the default averaging option that provides the desired visibility of subtle variations in RRa measurements.

Select the period of time the device should wait before alarming while it attempts to obtain a valid RRa reading.

5. Do one of the following:
 - To continue in the Advanced Settings, touch another tab.
 - To exit the Advanced Settings and return to the Home tab, touch **Exit**.

Specify advanced SpO2 settings

1. Access the Advanced Settings.
 - a. Touch the **Settings** tab.
 - b. Touch the **Advanced** tab.
 - c. Enter the **Advanced settings code**.
 - d. Touch **OK**.

The General tab appears.

2. Touch the **Parameters** tab.
3. Touch the **SpO2** tab.
4. Specify settings.

Setting

Default view

Default response

Sweep speed default

Action/Description

Select a numeric view or a waveform view as the default primary SpO2 display on the Home tab.

Select the default speed of response to changes in SpO2 measurements.

Select the default waveform sweep speed for the SpO2 display in the Home tab.

5. Do one of the following:
 - To continue in the Advanced Settings, touch another tab.
 - To exit the Advanced tabs and return to the Home tab, touch **Exit**.

Specify advanced pulse rate settings

1. Access the Advanced Settings.
 - a. Touch the **Settings** tab.
 - b. Touch the **Advanced** tab.
 - c. Enter the **Advanced settings code**.
 - d. Touch **OK**.

The General tab appears.

2. Touch the **Parameters** tab.
3. Touch the **Pulse rate** tab.
4. Specify settings.

Setting

Display source

Action/Description

Select this to show the source of pulse rate measurements (NIBP or SpO2) on the Home tab.

5. Do one of the following:
 - To continue in the Advanced Settings, touch another tab.
 - To exit the Advanced Settings and return to the Home tab, touch **Exit**.

Specify advanced etCO2 settings

1. Access the Advanced Settings.
 - a. Touch the **Settings** tab.

- b. Touch the **Advanced** tab.
- c. Enter the **Advanced settings code**.
- d. Touch **OK**.

The General tab appears.

2. Touch the **Parameters** tab.
3. Touch the **etCO2** tab.
4. Specify settings.

Setting

Default view

Display FiCO2

Waveform scale default

Unit of measure

Check calibration

Calibrate

Sweep speed default

Enable sampling line dialog

BTPS compensation

Calibration due hours

Maintenance due hours

Last calibration

Annual calibration

- For more calibration information, see the Service manual.

5. Do one of the following:
 - To continue in the Advanced Settings, touch another tab.
 - To exit the Advanced tabs and return to the Home tab, touch **Exit**.

Action/Description

Select a numeric view or a waveform view as the primary etCO2 display on the Home tab.

Select to display FiCO2 on the Home tab.

Select the default waveform scale in etCO2 measurements.

Select primary units of measure for the etCO2 display on the Home tab.

Select to start CO2 calibration check.

Select to start CO2 calibration.

Select the default waveform sweep speed for the CO2 waveform view on the Home tab.

Select to enable the sampling line dialog to be displayed when connecting a sampling line to the device.

Select to enable automatic adjustments for BTPS (body temperature pressure saturated) to improve the accuracy of CO2 measurements.

Displays time remaining until CO2 sensor calibration is required.

Displays time remaining until CO2 periodic sensor maintenance is required.

Displays date (XX/XX/XXXX) and time (00:00:00) of last calibration.

Displays anniversary date (XX/XX) of annual calibration.

Specify advanced SpHb settings

1. Access the Advanced Settings.
 - a. Touch the **Settings** tab.
 - b. Touch the **Advanced** tab.
 - c. Enter the **Advanced settings code**.
 - d. Touch **OK**.

The General tab appears.

2. Touch the **Parameters** tab.

3. Touch the **SpHb** tab.
4. Specify settings.

Setting

Default view

Unit of measure

Default averaging

Reference

Action/Description

Select a numeric view or a trend graph view as the primary SpHb display on the Home tab.

Select the primary unit of measure for the SpHb display on the Home tab.

Select the default moving window of time used by the parameter to calculate the SpHb value and update the display: short (approximately 1 minute), medium (approximately 3 minutes), or long (approximately 6 minutes).

Select arterial or venous as the calibrated reference source.

5. Do one of the following:
 - To continue in the Advanced Settings, touch another tab.
 - To exit the Advanced tabs and return to the Home tab, touch **Exit**.

Specify advanced NIBP settings

1. Access the Advanced Settings.
 - a. Touch the **Settings** tab.
 - b. Touch the **Advanced** tab.
 - c. Enter the **Advanced settings code**.
 - d. Touch **OK**.

The General tab appears.

2. Touch the **Parameters** tab.
3. Touch the **NIBP** tab.
4. Specify settings.

Setting

Default view

Unit of measure

Tube type

Algorithm default

Cuff inflation target

Action/Description

Select primary and secondary views.

Select **Display MAP** to display mean arterial pressure (MAP) in the NIBP frame on the Home tab.

If **Display MAP** is selected, specify which numerics are primary in the NIBP frame. On the Home tab, clinicians can touch the NIBP frame to toggle between views.

Select the NIBP unit of measure for display.

Select the number of tubes that are connected to the NIBP cuff used with this monitor. If you select **1 tube**, the only algorithm available for selection is **Step**.

Select the default algorithm used to determine NIBP measurements.

If you select the **Step** algorithm, touch  and enter a default cuff inflation target for each type of patient. Clinicians can change the CITs from the default CITs that

Allow interval program changes

you set here on the **Settings > Setup > NIBP** tab.

Select to enable user to modify interval program selections in the **Settings > Setup > Intervals** tab.

5. Do one of the following:
 - To continue in the Advanced Settings, touch another tab.
 - To exit the Advanced Settings and return to the Home tab, touch **Exit**.

Specify advanced temperature settings

1. Access the Advanced Settings.
 - a. Touch the **Settings** tab.
 - b. Touch the **Advanced** tab.
 - c. Enter the **Advanced settings code**.
 - d. Touch **OK**.

The General tab will appear.

2. Touch the **Parameters** tab.
3. Touch the **Temperature** tab.
4. Specify settings.

Setting

Unit of measure

Action/Description

Select primary units of measure for the temperature display on the Home tab

Display temperature conversion

Select this to display primary units of measure and secondary units of measure for the temperature display on the Home tab.

Default SureTemp Plus site

Select the default site for SureTemp measurements. The default site applies when clinicians power up the monitor and each time clinicians remove the temperature probe from the well.

Select **Last site** to set the default to the site selected for the last measurement.

5. Do one of the following:
 - To continue in the Advanced Settings, touch another tab.
 - To exit the Advanced Settings and return to the Home tab, touch **Exit**.

Specify the manual parameters

The Manual Parameters frame is in the lower right corner of the Home tab. You can manually enter values for parameters in the frame. In Advanced settings, you can specify which parameters appear in the frame and enable manual overrides of other parameter measurements displayed on the device.

1. Access the Advanced Settings.
 - a. Touch the **Settings** tab.
 - b. Touch the **Advanced** tab.
 - c. Enter the **Advanced settings code**.

d. Touch **OK**.

The General tab appears.

2. Touch the **Parameters** tab.
3. Touch the **Manual** tab.

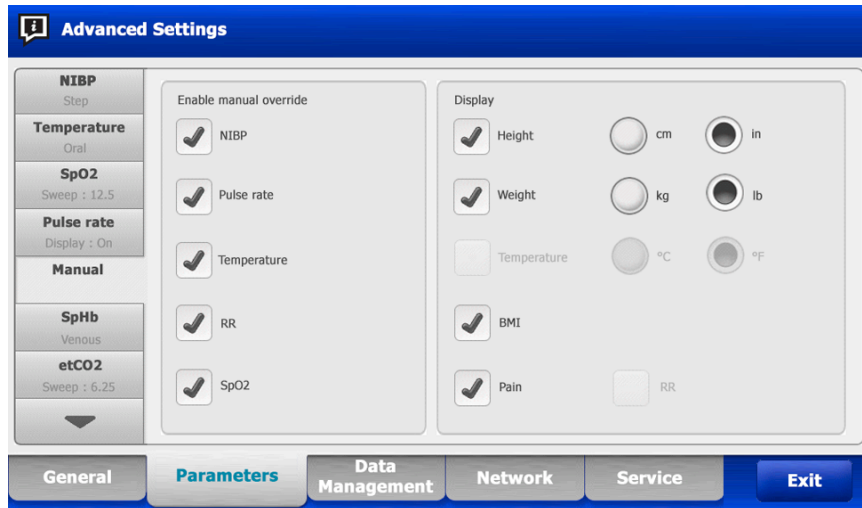

4. Select up to four parameters and associated units of measure for display in the Manual Parameters frame.

Note If the monitor has the SureTemp Plus temperature module, the Temperature parameter is not available here or in the Manual Parameters frame.

Note If the monitor is configured with CO2 or RRA, and you select the Continuous Monitoring profile before you enter Advanced settings, the respiration rate (RR) parameter is not available here or in the Manual Parameters frame. If any other profile is selected when you enter Advanced settings, the respiration rate (RR) parameter remains available for selection on this screen and is displayable in the Manual parameters frame.

5. Enable manual overrides of selected parameter measurements displayed on the device as desired.
6. Do one of the following:
 - To continue in the Advanced Settings, touch another tab.
 - To exit the Advanced Settings and return to the Home tab, touch **Exit**.

Data management

Specify patient settings

Patient identification appears on the Home tab in the Patient frame, and it is listed in various tabs, such as the Patient tab and the Review tab.

1. Access the Advanced Settings.
 - a. Touch the **Settings** tab.

- b. Touch the **Advanced** tab.
- c. Enter the **Advanced settings code**.
- d. Touch **OK**.

The General tab appears.

2. Touch the **Data Management** tab.
3. Touch the **Patient** tab.
4. Specify settings.

Setting

Default patient type

Name format

Primary label

Secondary label

Require patient ID to save readings

Search by patient ID

Clear patient information on manual save

Retrieve list

Action/Description

Select a default patient type for this monitor. The patient type shows in the Patient frame on the Home tab.

In the Summary tab on the Patients tab, clinicians can change the displayed patient type from the default patient type that you set here.

Select a format for all displayed patient names: **Full name** or **Abbreviation**.

Select the primary identification label for all displayed patients.

Select a secondary identification label for patients. A secondary label displays only on the Home tab, after the primary label.

Make entering a patient ID a prerequisite for saving measurements. If the clinician fails to enter an identifier, the monitor prompts the clinician when they try to save.

Enable clinicians to enter a patient ID to query for the patient's information. If clinicians scan the ID onto the Home tab or the Summary tab, the monitor queries the patient list and the network. Returned patient information populates the Patient frame on the Home tab and fields on the Summary tab.

Select **Require patient ID match to save measurements** to require that the selected patient ID matches a patient ID in the Patient list of the device or an external host system before you can save measurements.

Specify that the monitor clears the selected patient after a clinician manually saves measurements from the Home tab. Patient information clears from the Patient frame and the Summary tab.

Note This setting does not take effect when intervals are in progress.

Enable the monitor to retrieve the patient list from the network. When this option is selected, a **Retrieve list** button replaces the **Add** button on the List tab. Information from the network populates the List tab when clinicians touch the **Retrieve list** button. Since the **Add** button is not available, clinicians cannot add a patient to the patient list.

5. Do one of the following:
 - To continue in the Advanced Settings, touch another tab.
 - To exit the Advanced Settings and return to the Home tab, touch **Exit**.

Specify clinician settings

Clinician identification appears next to the medicine symbol in the Device Status area on the Home tab.

1. Access the Advanced Settings.
 - a. Touch the **Settings** tab.
 - b. Touch the **Advanced** tab.
 - c. Enter the **Advanced settings code**.
 - d. Touch **OK**.

The General tab appears.

2. Touch the **Data Management** tab.
3. Touch the **Clinician** tab.
4. Specify settings.

Setting

Label

Action/Description

Select a type of clinician identification label for display on the Home tab: **Full name**, **Abbreviation**, **Clinician ID**, or **Symbol only**.

Require clinician ID to save readings

Make entering a clinician ID a prerequisite for saving measurements. If they fail to enter identification, the monitor prompts them when they try to save measurements. Clinicians can enter clinician identification on the Clinician tab.

Clear clinician information on manual save

Specify that the monitor clears the selected clinician after a clinician manually saves measurements from the Home tab. Clinician information clears from the Clinician tab and the Device Status area.

Search by clinician ID

Enable the monitor to query the network for clinician information based on ID. The monitor initiates the search when the clinician enters or scans the ID from the Clinician tab. Returned clinician information populates the Device Status area and fields on the Clinician tab.

Select **Require password** to require clinicians to enter their password, in addition to ID, on the Clinician tab. The monitor uses the ID and password combination to query the network for clinician information.

Select **Require clinician ID match to save measurements** to require that the selected clinician ID matches a clinician ID in an external host system before you can save measurements.

5. Do one of the following:
 - To continue in the Advanced Settings, touch another tab.
 - To exit the Advanced Settings and return to the Home tab, touch **Exit**.

Specify clinical data settings

1. Access the Advanced Settings.
 - a. Touch the **Settings** tab.
 - b. Touch the **Advanced** tab.
 - c. Enter the **Advanced settings code**.

d. Touch **OK**.

The General tab appears.

2. Touch the **Data Management** tab.
3. Touch the **Clinical Data** tab.
4. Specify settings.

Setting

Automatically send on manual save

Action/Description

Select this option to specify that measurements are sent to the network when a clinician saves measurements on the Home tab.

Note When the device is in the Continuous Monitoring profile, this setting is grayed out.

Note When the monitor is not connected to the network, measurements saved on the monitor are sent to the network with the first successful send after reconnecting to the network.

Delete readings after successful send

Select this option to specify that measurements are deleted from the monitor after they are successfully sent to the network. Sent measurements do not appear in the Review tab.

Emulate Spot Vital Signs LXi

Select this option to specify that clinical data sent to the network appears as Spot Vital Signs LXi data at the network.

Connect to CS

Select to enable connection to the Connex central station.

5. Do one of the following:
 - To continue in Advanced Settings, touch another tab.
 - To exit the Advanced Settings and return to the Home tab, touch **Exit**.

Network

View advanced monitor information

The Status tab shows the monitor's software version, MAC and IP addresses, network, server and access point information, session information, and more.

1. Access the Advanced Settings.
 - a. Touch the **Settings** tab.
 - b. Touch the **Advanced** tab.
 - c. Enter the **Advanced settings code**.
 - d. Touch **OK**.

The General tab appears.

2. Touch the **Network** tab.
3. Touch the **Status** tab.
4. View the information.
5. Do one of the following:
 - To continue in the Advanced Settings, touch another tab.
 - To exit the Advanced Settings and return to the Home tab, touch **Exit**.

Specify radio settings

This task is applicable only to monitors that have a radio installed.

1. Access the Advanced Settings.
 - a. Touch the **Settings** tab.
 - b. Touch the **Advanced** tab.
 - c. Enter the **Advanced settings code**.
 - d. Touch **OK**.

The General tab appears.

2. Touch the **Network** tab.
3. Touch the **Radio** tab.
4. Specify settings.

Setting

Enable radio

Action/Description

Enable the radio for device communications. When disabled, the radio is not available.

Enable radio network alarms

Activate radio network alarms when an alarm condition occurs. When disabled, radio network alarms are not available.

SSID

Touch  and enter the service set identifier (SSID). SSIDs that are longer than 16 characters may be truncated in the user view. Enter a maximum of 32 characters.

Radio band

Select the radio band.

Authentication type

Select an authentication scheme. Then specify any additional settings that appear.

Method

Select a method. Then touch  and enter characters: **Network key** (64 characters), or **Passphrase** (8 to 63 characters).

Note The characters you enter for **Network key** and **Passphrase** appear as asterisks on the keyboard and then on the Radio pane.

Security protocol

Select the security protocol.

EAP type

Select the EAP type.

Identity

Enter the EAP identity (maximum of 32 characters).

Password

Enter the EAP password (maximum of 32 characters).

Key number

Select the WEP key number.

Key

Enter the WEP key (10 characters for WEP 64, or 26 characters for WEP 128).

Configure radio

Touch **Configure radio** to activate all new radio settings not selected previously.

Touch **OK** in the confirmation popup telling you to power down the monitor.

Touch the **Settings** tab. Touch the **Device** tab. Touch **Power down**.

The radio will reboot.

Note None of the changed radio settings take effect until you touch **Configure radio**.

5. Do one of the following:
 - To continue in the Advanced Settings, touch another tab.
 - To exit the Advanced Settings and return to the Home tab, touch **Exit**.

Specify server settings

1. Access the Advanced Settings.
 - a. Touch the **Settings** tab.
 - b. Touch the **Advanced** tab.
 - c. Enter the **Advanced settings code**.
 - d. Touch **OK**.

The General tab appears.
2. Touch the **Network** tab.
3. Touch the **Server** tab.
4. Select the method used to identify the IP address of the server with which the device will communicate.
5. Specify settings.

Setting

Broadcast

VM IP

NRS IP



DNS name

Action/Description



Enable the device to broadcast a request to obtain an IP address for a selected service. Specify the port to match

the port used by the server. Touch  in the Port entry field and enter the port number. The range of entry is 0 to 65535.

Enable the device to connect to a Connex Vitals Management (VM) Datacatcher or other server at a fixed

IP address. Touch  in the Vitals Management server IP address fields and enter the IP address. Touch  in the Port entry field and enter the port number. The range of entry is 0 to 65535.

Enable the device to connect to a Network Rendezvous

Service (NRS) at a fixed IP address. Touch  in the Network rendezvous service IP address fields and enter the IP address. Touch  in the Port entry field and enter the port number. The range of entry is 0 to 65535.

Enable the device to connect to a Network Rendezvous Service (NRS) by entering a hostname to be sent to a Domain Name Server (DNS) to retrieve the NRS IP

address. Touch  in the Network rendezvous service

DNS name field and enter the DNS name. Touch  in the Port entry field and enter the port number. The range of entry is 0 to 65535.

Note The DNS name option is only available in the following conditions:

DHCP	<ul style="list-style-type: none"> • The version of the installed radio is 3.00.02 or greater • The radio is disabled • No radio is installed
Restore defaults	<p>Enable the device to connect to a Network Rendezvous Service (NRS) by entering a port number and then connecting at an address provided by the DHCP43 response. Touch  in the Port entry field and enter the port number. The range of entry is 0 to 65535. After touching Test and successfully connecting to the server, the NRS IP addresses appear onscreen.</p> <p>Touch Restore defaults to restore settings for the selected option to the default values.</p>
Test	<p>Touch Test to test the connection to the configured server.</p>

6. Do one of the following:

- To continue in the Advanced Settings, touch another tab.
- To exit the Advanced Settings and return to the Home tab, touch **Exit**.

Service

The Service tab presents numerous settings and controls typically accessed by authorized service or biomedical engineering personnel to configure, maintain, test, and update the device. For example, the Service tab enables authorized users to save device configurations to a USB flash drive and then load saved configurations to other devices. Systems and devices configured with the PartnerConnect™ service feature also have access to remote diagnostics, troubleshooting, and software upgrades.

For a description of service-related advanced settings, see the service manual for this product.

Troubleshooting

This section presents tables of technical alarm and information messages, as well as problem descriptions that do not generate messages, to help you troubleshoot issues on the monitor.

Note Problem descriptions without messages appear at the end of this section.

When the monitor detects certain events, a message appears in the Device Status area at the top of the screen. Message types include the following:

- Information messages, which appear on a blue background.
- Very low-priority alarms, which appear on a cyan background.
- Low- and medium-priority alarms, which appear on an amber background.
- High-priority alarms, which appear on a red background.

Technical alarm messages are low or very low priority unless noted in the Message column.

You can dismiss a message by touching the message on the screen, or, for some messages, you can wait for the message to time out.

To use these tables, locate the message that displays on the monitor in the left column of the table. The remainder of the row explains possible causes and suggests actions that can resolve the issue.

Note Instructions to "Call for service" in the following tables mean that you should contact qualified service personnel in your facility to investigate the issue.

Patient movement messages

Message	Possible cause	Suggested action
Replace the bed sensor.	The sensor is faulty or expired	Replace the bed sensor.
	The cable is faulty or expired	Replace the cable.
The bed sensor is disconnected.	The bed sensor is disconnected from the monitor	Check the bed sensor cable to ensure that connections to the monitor and the extension cable are tight.
	The bed sensor is disconnected from the extension cable	

Message	Possible cause	Suggested action
The bed sensor is upside down.	The bed sensor was not placed properly under the mattress, mattress cover, or mattress pad	Turn the sensor right-side up.
Cannot measure patient. Lost or unstable signal.	The sensor is not under the patient's chest (Low confidence condition)	Reposition the sensor under the patient's chest.
	The sensor is turned 90 degrees, placed vertically (Low confidence condition)	Place the sensor horizontally under the patient's mattress, with the cable extending toward the head of the bed.
	There is excessive patient movement (Low confidence condition)	Check the patient. Replace the bed sensor.
	An unqualified mattress type is in use	Switch to a qualified mattress type.
Cannot measure respiration.	The sensor is not under the patient's chest (Low confidence condition)	Adjust the position of the sensor under the patient's chest.
	The sensor is turned 90 degrees, placed vertically (Low confidence condition)	Place the sensor horizontally under the patient's mattress, with the cable extending toward the head of the bed.
	There is excessive patient movement (Low confidence condition)	Check the patient. Replace the bed sensor. Use an alternative sensor to monitor respiration.
	An unqualified mattress type is in use	Switch to a qualified mattress type.
Cannot measure pulse rate.	The sensor is not under the patient's chest (Low confidence condition)	Adjust the position of the sensor under the patient's chest.
	The sensor is turned 90 degrees, placed vertically (Low confidence condition)	Place the sensor horizontally under the patient's mattress, with the cable extending toward the head of the bed.
	There is excessive patient movement (Low confidence condition)	Check the patient. Replace the bed sensor. Use an alternative sensor to monitor pulse rate.
	An unqualified mattress type is in use	Switch to a qualified mattress type.
EarlySense not functional.	A module error occurred	Call for service.
Bed sensor expires in ...	The bed sensor expires soon	Replace the bed sensor before it expires.
The sensor has expired.	The bed sensor has expired	Replace the sensor.

Message	Possible cause	Suggested action
The sensor is defective.	A sensor error occurred	Replace the sensor.
Trend change detected. Review patient history.	Patient measurements have changed enough to require attention	Check the patient and patient history.

CO2 messages

Message	Possible cause	Suggested action
CO2 not functional. Call for service.	A nonrecoverable communications error has occurred	Call for service.
Filter line disconnected.	The sampling line is not connected to the monitor	Connect a sampling line to the monitor. Check to ensure that the sampling line plug is tightly connected to the monitor.
Check for occlusion in gas line.	The purge cycle failed to clear a blockage in the sampling line	Replace the sampling line.
CO2 temperature out of range. CO2 might not be accurate.	CO2 module temperature is out of range	Wait for the module temperature to return to normal and the module to reset before calibrating CO2. Move to a location where the ambient temperature enables the module temperature to return to normal and the module to reset before calibrating CO2.
Connect or clear filter line.	Calibration failed because sampling line is blocked or kinked	Check sampling line for obstruction or kinks. Replace the filter line if necessary.
	Module is not ready for calibration because the sampling line is not connected to the monitor	Check to ensure that the sampling line plug is tightly connected to the monitor.
Purging filter line.	An occlusion was detected in the sampling line, which automatically initiated a purge cycle	Wait for the purge cycle to clear the blockage and the module to be reset.
Check calibration gas concentration.	The calibration gas is not flowing	Check that the calibration gas is turned on.
	The calibration gas has the wrong CO2 concentration	Check that the calibration gas has the correct concentration.
Check calibration gas flow.	The calibration gas flow is unstable	Check the sampling line for kinks or obstructions. Check all tubing connections for leaks.

Message	Possible cause	Suggested action
		Check that the gas source is not running out.
Check exhaust port for obstruction.	The exhaust port is blocked Internal flow problem	Call for service.
Calibration overdue. CO2 might not be accurate.	The due date for calibration has passed	Perform CO2 calibration or call for service.
Factory service overdue. CO2 might not be accurate.	The due date for factory service has passed	Call for service.
Calibration failed. <i>Error message here.</i>	The calibration failed for the reason named in the error message	Check the error message and take corrective action presented.
Calibration completed successfully.	An uninterrupted, error-free calibration took place	Resume using the monitor.
Calibration aborted.	You or some other user interrupted the calibration	Resume or retry calibration.

RRa messages

Message	Possible cause	Suggested action
Respiratory freshness timeout expired.	Excessive ambient or environmental noise	Reduce the level of noise in the room.
	Poor sensor placement on the patient	Remove the sensor from the patient and reapply.
	The patient cable or sensor is defective	Replace the patient cable or sensor.
Replace RRa probe.	The sensor is faulty	Replace the sensor.
	No sensor is connected	Connect the sensor.
	The cable is faulty	Replace the cable.
RRa patient interference detected.	Poor sensor placement on the patient	Remove the sensor from the patient and reapply.
	The patient is talking	Ask the patient to limit talking.
	The patient is snoring	Gently adjust the patient's position to reduce snoring. Awaken and ask the patient to adjust their position to reduce snoring.

Message	Possible cause	Suggested action
RRa background interference detected.	Excessive ambient or environmental noise	Reduce the level of noise in the room.

NIBP messages

Message	Possible cause	Suggested action
NIBP air leak; check cuff and tubing connections.	The NIBP module has an air leak	Check the cuff, tubing, and connections for leaks. If no leaks are found, clear the alarm and retry NIBP. If the message reappears, call for service to replace the NIBP module.
NIBP not functional. Call for service.	A module error occurred	Call for service.
	The ambient temperature is out of range	Use the monitor in the specified temperature range.
Unable to determine NIBP; check connections; limit patient movement.	The NIBP module detected a motion artifact	Check connections; limit patient movement. Clear the alarm and retry NIBP.
Unable to determine NIBP; check connections and tubing for kinks.	The NIBP tubing on the outside of the device has a kink	Check the connections and tubing for kinks. Clear the alarm and retry NIBP.
	The NIBP module needs to be calibrated	Call for service to calibrate the NIBP module.
	Tubing inside the NIBP module is kinked	Call for service to replace the NIBP module.
Incorrect NIBP cuff size; check patient type.	The cuff size is not correct for the selected patient type	Check the patient type and cuff size. Clear the alarm and retry NIBP.
Inflation too quick; check NIBP cuff and tubing connections.	NIBP inflation was too quick	Check the connections and tubing for kinks. Clear the alarm and retry NIBP.
Unable to determine NIBP; check inflation settings.	Target pressure is too low	Check inflation settings and change as necessary. Clear the alarm and retry NIBP.
		Change the cuff inflation target (CIT).
Excessive patient movement.	The NIBP module detected a motion artifact	Touch OK to dismiss. Limit patient movement and retry NIBP.

Message	Possible cause	Suggested action
Tube type does not match device configuration. (NIBP measurement is available)	The tube connected to the NIBP sensor does not match the monitor's configuration	Touch OK to dismiss. Use the tube type specified for the monitor.
Tube type does not match device configuration. (NIBP measurement is not available)	User is using a single-lumen tube with the following Advanced settings: 1. Patient type is Pediatric or Adult 2. Tube type is 2 3. Algorithm is SureBP	Clear message. Modify settings or tube use to match patient type.

SpO2 and SpHb messages

Message	Possible cause	Suggested action
SpO2 not functional. Call for service.	A module error has occurred	Try a new cable/sensor pair. Call for service.
Searching for pulse signal. (High-priority alarm)	The SpO2 sensor is not attached to the patient's finger	Touch the alarm icon or the SpO2 frame to dismiss the alarm. Set SpO2 alarm limits to OFF. Reattach the SpO2 sensor to the patient's finger.
Attach SpO2 sensor to monitor.	The sensor was not detected	Check the sensor connection. Replace the SpO2 sensor.
Replace the SpO2 sensor.	The SpO2 sensor is faulty or expired	Replace the SpO2 sensor.
	No SpO2 sensor is connected	Connect an SpO2 sensor.
	The cable is faulty or expired	Replace the cable.
Replace the SpO2 cable.	The cable is faulty or expired	Replace the cable.
Low SpO2 signal quality. Check sensor.	Poor sensor placement on the patient	Remove the sensor from the patient and reapply.
Low SpHb signal quality. Check sensor.	The patient cable or sensor is defective	Call service to test or replace the module.
Low perfusion. Check sensor.	The SpO2 module is faulty	Remove the sensor from the patient and reapply.
SpO2 mode only. Check sensor or cable.	The sensor is operating as an SpO2-only sensor because it failed to calibrate properly	Reattach the cable to the monitor. Remove the sensor from the patient and reapply.
SpO2 sensor expires in...	The SpO2 sensor will expire soon	Replace the SpO2 sensor.

Message	Possible cause	Suggested action
Note This message only appears on devices configured with SpHb.		

Temperature messages

Message	Possible cause	Suggested action
Connect temperature probe.	No probe is connected	Connect a temperature probe and retry.
	The probe is faulty	Replace the temperature probe.
	The temperature module returned a connect probe message	Connect a temperature probe and retry. If a probe is already connected, replace the probe.
Insert correct color-coded probe well.	The probe well is missing	Insert a temperature probe well.
Replace temperature probe.	The probe is faulty	Replace the temperature probe.
Temperature not functional. Call for service.	A module error occurred	Call for service.
Temperature time limit exceeded. Retry temperature measurement.	The direct mode timed out	Remove the probe from the measurement site.
Tissue contact lost.	The probe has lost contact with the patient's tissue	Touch OK to dismiss the message. Return the probe to the probe well and retry patient temperature measurement. Ensure that the probe makes proper contact with the patient's tissue.
Retry temperature measurement. Note This message often accompanies other temperature messages.	A probe heater or data error occurred	Retry the temperature measurement. If the problem persists, replace the probe.
	User settings require adjustment	Adjust the user settings and retry.
	The ambient temperature is out of range	Operate the monitor within the specified temperature range. Retry patient temperature measurement.
	The SureTemp temperature module is faulty	Call for service.
Unable to detect new temperature. Retry measurement.	The Braun thermometer is removed from the dock or not seated properly in the dock	Return the thermometer to the dock or adjust the thermometer in the dock.
	The Braun dock is disconnected from the device	Connect the USB cable for the Braun dock to the device.

Message	Possible cause	Suggested action
Thermometer might be docked improperly. Check contacts and connections.	The Braun thermometer is removed from the dock or not seated properly in the dock	Return the thermometer to the dock or adjust the thermometer in the dock.
	The Braun dock is disconnected from the device	Connect the USB cable for the Braun dock to the device.

Weight scale messages

Message	Possible cause	Suggested action
Weight scale not functional. Call for service.	The weight scale is not operating properly.	Call for service.

Physical assessment instrument handles

Symptom	Possible cause	Suggested action
The lamp does not illuminate	There is no lamp in the handle head	Install a lamp in the handle head.
	The lamp is burned out	Install a new lamp.
	The other handle is off the cradle	Place the other handle in the cradle.
	The system is not powered up	Power up the system.
	The platform handle controller PCBA is defective	Call service.
The lamp is too dim	The rheostat setting is too low	Increase the rheostat setting.
	The platform handle controller PCBA is defective	Call service.
	The handle assembly is defective	Call service.
The lamp is too bright	The rheostat setting is too high	Decrease the rheostat setting.
	The platform handle controller PCBA is defective	Call service.
	The handle assembly is defective	Call service.
The lamp brightness does not adjust	The platform handle controller PCBA is defective	Call service.
	The handle assembly is defective	Call service.
The handle becomes very hot to the touch	The lamp has been on for an extended period of time	Return the handle to the cradle.

Patient data management messages

Message	Possible cause	Suggested action
Maximum number of patient records saved. Oldest record overwritten.	The maximum number of patient records in the monitor's memory has been exceeded	On the Review tab, delete old records to prevent the alarm from appearing when new records are saved.
No data saved.	No patient data is available	Take or enter vital signs before saving.
Patient ID required to save data.	The configuration requires a patient ID to save data	Call for service to modify advanced settings.
Clinician ID required to save data.	The configuration requires a clinician ID to save data	Call for service to modify advanced settings.
Patient ID required to send data.	The configuration requires a patient ID to send data	Add a patient ID.
Patient list is full. Delete some patients to add more.	The maximum number of patients was exceeded	Delete a patient from the list to add a new patient.
Stop intervals to select new patient.	The monitor is set to take interval readings	Stop intervals before changing the patient.
No connection for send.	No connectivity is available to support sending data manually or automatically sending data on manual save	Call for service to check the network connection or wireless settings.
Unable to retrieve list.	The monitor is unable to retrieve a patient list from the network	Call for service to check the network connection or wireless settings, or to verify that the server is available.
Unable to identify clinician.	The clinician ID or password is incorrect	Confirm the clinician ID and password (if applicable), and retry.
Unable to identify patient. Touch Clear to delete all data.	The patient ID does not match an ID in the patient list or network	Re-enter the patient ID. <hr/> To delete all unsaved data, touch Clear .
Unable to identify clinician. Touch Clear to delete all data.	The clinician ID does not match an ID in the network	Re-enter the clinician ID. <hr/> To delete all unsaved data, touch Clear .

Communications module messages

Message	Possible cause	Suggested action
Communications module did not power on properly. Power down the device. (High-priority alarm)	Communication failure	Call for service.

Radio messages

Message	Possible cause	Suggested action
Radio not functional. Call for service.	A hardware failure occurred	Call for service to update the radio software or replace the radio.
	The radio has the wrong software	
Radio error. Power down and restart.	The monitor and the radio failed to establish communication with each other	Power down and restart. If problem persists, call for service.
Unable to establish network communications. Radio out of network range.	The radio is no longer communicating with the access point	Call for service to verify that the device is within the radio coverage area and is configured to the network.
Unable to establish network communications. Call for service.	Unable to get an IP address from the DHCP server	Call for service to verify that the server is available.

Ethernet messages

Message	Possible cause	Suggested action
Network not found; check network cable connection.	A network cable is unplugged	Check the network cable connection. If problem persists, call for service.
	A network connection is broken elsewhere	

USB and USB flash drive messages

Message	Possible cause	Suggested action
USB Communication failure. Call for service.	An internal or external device is connected but failed enumeration	Power down and restart.
		Check USB connections.
		If problem persists, call for service.
External device not licensed for use.	A license for an external device (e.g., barcode scanner) has not been activated	Disconnect the unlicensed device. Call for service to obtain the authorization code from Welch Allyn to activate the license.

Message	Possible cause	Suggested action
External device not recognized.	An unrecognized external device is connected	Disconnect the unrecognized device.
Incompatible Welch Allyn device.	A communication protocol failure has occurred	Call for service.
USB accessory disconnected.	The USB cable between an external device and the monitor is disconnected	Confirm that the USB cable is connected to the device and the monitor.
Save not successful.	Missing, improperly inserted, or incompatible USB flash drive	Dismiss message and insert a compatible USB flash drive.
Unable to save configuration to USB.	Missing, improperly inserted, or incompatible USB flash drive	Dismiss message and insert a compatible USB flash drive.

System messages

Message	Possible cause	Suggested action
Set date and time.	The date or time is not set	Set the date and time.
	The date or time is not set properly	Reset the date or time.
Device shutdown is not available at this time.	Device cannot perform an immediate shutdown	Touch OK , wait, and retry.
Advanced settings unavailable.	Sensors are taking measurements	Stop continuous measurements.
	A physiological alarm condition is active	Respond to or reset the alarm.
	Spot Check measurements have not been saved	Save the measurements.
Unexpected restart occurred. Call for service.	A system error caused the monitor to restart.	Call for service.

Battery power manager messages

Message	Possible cause	Suggested action
Low battery 5 minutes or less remaining. (High-priority alarm)	Battery power is extremely low	Connect the monitor to AC power. (If not connected to AC power, the monitor powers down when battery power is depleted.)
Low battery 30 minutes or less remaining.	Battery power is low	Touch the alarm icon to dismiss or connect the monitor to AC power.
Battery is absent or faulty.	There is no battery in the monitor	Insert a battery.
Battery is absent or faulty. Call for service.	The battery is faulty	Replace the battery.

Message	Possible cause	Suggested action
Device is operating in battery mode.	The AC power cord has been disconnected	Touch OK to dismiss or connect the monitor to AC power.

Configuration Manager messages

Message	Possible cause	Suggested action
Unable to load configuration; using factory defaults.	A configuration load error occurred	Call for service.
Functional error. Call for service.	A critical configuration load error occurred	Call for service.
No connection for send.	The monitor is not configured to the network	Call for service.

Printer messages

Message	Possible cause	Suggested action
Low battery, unable to print; plug into outlet.	The monitor's battery voltage is too low to support printing	Connect the monitor to AC power.
Printer door is open; close to continue.	The printer door is open	Close the printer door.
Out of paper.	The paper is not properly loaded	Align the paper with the print head. If the problem persists, call for service.
	The paper sensor does not detect paper	Replace the paper. If the problem persists, call for service.
Printer too hot; wait to retry.	The print head overheated	Wait for the print head to cool down and retry. If the problem persists, call for service.
External device not recognized.	An external printer is plugged into a USB port	Unplug the external printer.
Printer not functional. Call for service.	The printer motor is broken	Call for service.
	The detection switch malfunctioned	
	A hardware failure occurred in the power supply	
	The printer does not identify itself correctly	
	The printer does not enumerate	
Printing records:	The monitor is printing the records selected on the Review tab	Acknowledge the number of records printing or touch Cancel to interrupt printing.
<p>Note The number of records requested appears in the message and counts down during printing.</p>		

Message	Possible cause	Suggested action
Printing report; please wait.	The printer needs more time to complete a print job when the Automatic print on interval control has been enabled	Wait for the print job to print completely. Disable Automatic print on interval in Intervals settings.

Network messages

Message	Possible cause	Suggested action
Lost connectivity with host.	The central station or other host application has stopped running or is not operating properly	Confirm that the host application is running properly.

Problems and solutions

The problems addressed in this table do not generate alarm or information messages on the monitor.

Problem	Possible cause	Suggested action
No SpHb value is displayed	An SpO2-only cable is connected to the monitor	Replace the SpO2-only cable with an SpO2/SpHb (Masimo rainbow) cable.
	The SpO2/SpHb reusable sensor has expired	Replace the sensor.
	Note A technical alarm appears.	
	Poor sensor placement on the patient	Remove the sensor from the patient and reapply.
No weight measurement is transferred from the scale to the monitor	The monitor may have the SpHb license, but the SpO2 module does not	Contact Welch Allyn to verify that the SpO2 module contains the SpHb license.
	The scale is not connected	Inspect the USB cables from the device to the adapter to the scale to ensure that they are connected properly.
	The scale setting is incorrect	Ensure that the scale settings are enabled for transfer.

Specifications

Physical specifications

Protection classifications, all monitor configurations

Characteristic	Specification
Electrical rating	100 – 240 V AC, 50 – 60 Hz, 0.8 – 1.5 A
Duty cycle	Continuous operation
Duty cycle - physical assessment handles	2 minutes on, 10 minutes off
Type of protection against electric shock	Class I equipment (protectively earthed) with double insulation
Degree of protection against electric shock, for parts applied to patients	Type BF defibrillator proof IEC EN 60601-1, 2nd Edition
Recovery time following defibrillator discharge	Less than or equal to 10 seconds
Flammable anesthetics	 WARNING Not suitable for use with flammable anesthetics.
Degree of protection provided by the enclosure with respect to harmful ingress of liquids	IPX0 Non-protected according to EN/IEC 60529; Pulse oximeter equipment complies with ISO 9919 Cl. 44.6 Ingress of liquids tests and EN/IEC 60601-1, 60601-2-30, 60601-2-49 Cl. 44.3 Spillage tests

Vital Signs Monitor 6000 Series

Height	Standard chassis: 10 in. (25.4 cm) Extended chassis: 10 in. (25.4 cm)
Width	Standard chassis: 11 in. (27.9 cm) Extended chassis: 11.38 in. (28.9 cm)
Depth	Standard chassis: 6 in. (15.3 cm) Extended chassis: 7.5 in. (19.1 cm)

Protection classifications, all monitor configurations

Weight (including battery)	Standard chassis: 9.5 lb (4.3 kg) Extended chassis: 10.4 lb (4.7 kg)
----------------------------	---

Integrated Wall System

Height	10.56 in. (268.26 mm)
Width	39.92 in. (1014 mm)
Depth	7.51 in. (190.8 mm)
Weight (including battery)	14.1 lb. (6 kg)

Graphical display resolution

Display area	8 in. (H) x 4 in. (V) (19.5 [H] cm x 11.3 [V] cm)
Pixels	1024 (H) x 600 (V)
Pixel arrangement	RGB (red, green, blue)
Color depth	16 bits per pixel

Speaker volume

Vital Signs Monitor 6000 Series

Output sound pressure	67 dB at 1.0 meter
-----------------------	--------------------

Integrated Wall System

Output sound pressure	57 dB at 1.0 meter
Measured sound range	46 – 66 dB(A)

Alarm and pulse tones

Pulse frequency (f_0)	150 – 1000 Hz
Number of harmonic components in the range 300 Hz to 4000 Hz	minimum of 4
Effective pulse duration (t_d)	high priority: 75 – 200 ms medium and low priority: 125 – 250 ms
Rise time (t_r)	10 – 20% of t_d
Fall time ^a (t_f)	$t_f \leq t_s - t_r$

Note The relative sound pressure level of the harmonic components should be within 15 dB above or below the amplitude at the pulse frequency.

Protection classifications, all monitor configurations

^a Prevents overlap of pulses.

Battery specifications	6 cell	9 cell
Rating	11.1 V 3.80Ah (42Wh)	10.8 V 6.75Ah (73Wh)
Composition	Lithium-ion	Lithium-ion
Charge time to 80% capacity	2hr 7m	2hr 25m
Charge time to 100% capacity	3hr	4hr
Patient exams per charge ¹	26	47
Age to 70% capacity ²	300	300
Operating time per charge for continuous monitoring ^{3,4}	Do not use	2hr (only if clinician remains in the room)

¹A patient exam includes NIBP, Temperature, and SpO2 measurements at the rate of one patient every 10 minutes with a 2-minute display time out setting and a new battery.

²After this many full charge and discharge cycles, the battery has aged to where its total capacity has been reduced to 70% of its rating.

³ This specification is based on a monitor with the following characteristics:

- A new, fully charged 9-cell battery
- CO2, SpO2, SpHb and the radio operating continuously
- One blood pressure measurement every 10 minutes
- One printout every 10 minutes

As batteries age, their capacity diminishes. Replace the battery when a noticeable decrease in operating time is observed or when total capacity is below 70% (as described in Note 2 above).

⁴ If battery power supplied to the monitor falls below the specified lower limit, the monitor powers down. There is no impact on monitor performance or accuracy as the battery charge runs down. A high-priority alarm occurs when a charge of 5 minutes or less remains on the battery. Plugging the monitor into a power outlet starts recharging the battery immediately and prevents the monitor from powering down.

Ethernet connection specifications

Ethernet	Communicates using 10base-T and 100-base T
----------	--

Nurse Call connection specifications

Nurse Call	25 V AC or 60 V DC maximum at 1A maximum
------------	--

Handle specifications

Handle output	3.00 - 3.90v, .700 - 1.5A
---------------	---------------------------

Handle specifications

Leakage current is less than 10 microamps from any exposed metal part.

NIBP specifications

Units of measure	Systolic, diastolic, MAP: mmHg, kPa; user-selectable Pulse rate: beats per minute
Cuff pressure range	Meets or exceeds ANSI/AAMI SP10:2002 standards for cuff pressure range
Systolic range	Adult: 30 to 260 mmHg (4.0 to 34.7 kPa) (StepBP, SureBP) Pediatric: 30 to 260 mmHg (4.0 to 34.7 kPa) (StepBP, SureBP) Neonate: 20 to 120 mmHg (2.7 to 16.0 kPa) (StepBP)
Diastolic range	Adult: 20 to 220 mmHg (2.7 to 29.3 kPa) (StepBP, SureBP) Pediatric: 20 to 220 mmHg (2.7 to 29.3 kPa) (StepBP, SureBP) Neonate: 10 to 110 mmHg (1.3 to 14.7 kPa) (StepBP)
Cuff Inflation Target	Adult: 160 mmHg (21.3 kPa) (StepBP) Pediatric: 120 mmHg (16.0 kPa) (StepBP) Neonate: 90 mmHg (12.0 kPa) (StepBP)
Maximum Target Pressure	Adult: 280 mmHg (37.3 kPa) (StepBP, SureBP) Pediatric: 280 mmHg (37.3 kPa) (StepBP, SureBP) Neonate: 130 mmHg (17.3 kPa) (StepBP)
Blood pressure determination time	Typical: 15 seconds Maximum: 150 seconds
Blood pressure accuracy	Meets or exceeds ANSI/AAMI SP10:2002 standards for noninvasive blood pressure accuracy, ± 5 mmHg (0.7 kPa) mean error, 8 mmHg (1.1 kPa) standard deviation
Mean Arterial Pressure (MAP) range The formula used to calculate MAP yields an approximate value.	Adult: 23 to 230 mmHg (3.1 to 30.7 kPa) (StepBP, SureBP) Pediatric: 23 to 230 mmHg (3.1 to 30.7 kPa) (StepBP, SureBP) Neonate: 13 to 110 mmHg (1.7 to 14.7 kPa) (StepBP)
Pulse rate range (using blood pressure determination)	Adult: 30 to 200 beats per minute (StepBP, SureBP) Pediatric: 30 to 200 beats per minute (StepBP, SureBP) Neonate: 35 to 220 beats per minute (StepBP)
Pulse rate accuracy (using blood pressure determination)	$\pm 5.0\%$ (± 3 beats per minute)
Overpressure cutoff	Adult: 300 mmHg ± 15 mmHg (40.0 kPa ± 2.0 kPa) Pediatric: 300 mmHg ± 15 mmHg (40.0 kPa ± 2.0 kPa) Neonate: 150 mmHg (20.0 kPa) maximum

SureTemp Plus temperature module specifications

Units of measure	°F, °C; user-selectable
Temperature range	80°F to 110°F (26.7°C to 43.3°C)
Calibration accuracy	±0.2°F (±0.1°C) (Direct mode)

Braun ThermoScan PRO 4000 thermometer specifications (refer to manufacturer's directions for use for additional information)

Units of measure	°F, °C; user-selectable
Temperature range	68°F to 108°F (20°C to 42.2°C)
Calibration accuracy	<ul style="list-style-type: none"> ±0.4°F (±0.2°C) for temperatures ranging from 95.9°F to 107.6°F (35.5°C to 42°C) ±0.5°F (±0.3°C) for temperatures outside of this range
Display resolution	0.1°F or °C

Nellcor specifications (for additional information, refer to the directions for use that accompanies each accessory)

SpO2

Unit of measure	%
Measurement range	1% to 100%
Nellcor sensor accuracy guide	SpO2 measurement accuracy can only be evaluated in vivo by comparing pulse oximeter readings with SaO2 measurements obtained from simultaneously sampled arterial blood made using a laboratory CO-oximeter. SpO2 accuracy was validated through breathe-down-equivalent testing by Covidien using electronic measurements to prove equivalence to the Nellcor N600x predicate device. The Nellcor N600x predicate device was validated by performing human-subject, "breathe-down" clinical trials.

Accuracy	Note	Saturation accuracy varies by sensor type. The worst case accuracy range of the module or the attached sensor will apply.
----------	-------------	---

Saturation accuracy (module)	±3 digits 70% to 100% Adult, Pediatrics: ± 2 digits Neonate: ± 3 digits Low Perfusion: 0.02% to 20% ± 2 digits
------------------------------	--

Saturation accuracy (sensors)	Sensor	Accuracy
-------------------------------	---------------	-----------------

Nellcor specifications (for additional information, refer to the directions for use that accompanies each accessory)

60% to 80%	MAX-AI, MAX-PI, MAX-II	±3 digits
70% to 100%	DS-100A	±3 digits
	D-YS	Infants, Pediatrics, Adults: ±3 digits Neonates: ±4 digits
	D-YSE	±4 digits
	D-YSPD	±4 digits
	MAX-AI, MAX-PI, MAX-II	±2 digits
	OXI-A/N	Adults: ±3 digits Neonates: ±4 digits
	OXI-P/I	±3 digits

Electrical/Optical Specifications	Nellcor pulse oximetry sensors contain light-emitting diodes (LEDs) that emit red light at a wavelength of approximately 660 nm, and infrared light at a wavelength of approximately 900 nm. The total optical output power of the sensor LEDs is less than 15 mW. This information might be useful to clinicians, such as those performing photodynamic therapy.
-----------------------------------	---

Pulse rate

Unit of measure	beats per minute
Measurement range	20 to 250 beats per minute
Accuracy	±3 digits

 Functional tester

WARNING Functional testers cannot be used to assess the accuracy of a pulse oximeter monitor.¹

¹ Some models of commercially available bench-top functional testers and patient simulators can be used to verify the proper functionality of Nellcor pulse oximeter sensors, cables and monitors. See the individual testing device's operator's manual for the procedures specific to the model of tester being used.

While such devices may be useful for verifying that the pulse oximeter sensor, cabling, and monitor are functional, they are incapable of providing the data required to properly evaluate the accuracy of a system's SpO₂ measurements. Fully evaluating the accuracy of the SpO₂ measurements requires, at a minimum, accommodating the wavelength characteristics of the sensor and reproducing the complex optical interaction of the sensor and the patient's tissue. These capabilities are beyond the scope of known bench-top testers. SpO₂ measurement accuracy can only be evaluated in vivo by comparing pulse oximeter readings with SaO₂ measurements obtained from simultaneously sampled arterial blood made using a laboratory CO-oximeter.

Many functional testers and patient simulators have been designed to interface with the pulse oximeter's expected calibration curves and may be suitable for use with Nellcor monitors and/or sensors. Not all such devices, however, are adapted for use with the Nellcor OXIMAX digital calibration system. While this will not affect use of the simulator for verifying system functionality, displayed SpO₂ measurement values may differ from the setting of the test device. For a

properly functioning monitor, this difference will be reproducible over time and from monitor to monitor within the performance specifications of the test device.

Masimo specifications (for additional information, refer to the directions for use that accompanies each accessory)

SpO₂

Unit of measure	%
Measurement range	0% to 100%
Masimo SpO ₂ sensor accuracy guide	Accuracy specified when used with Masimo SET pulse oximetry monitors or with licensed Masimo SET pulse oximetry modules using PC series patient cables, during no motion. Numbers present ± 1 standard deviation. Plus or minus one standard deviation represents 68% of the population.

Accuracy ¹	Note	Saturation accuracy varies by sensor type. For additional sensor accuracy information, refer to the DFU that accompanies the sensor.
-----------------------	-------------	--

70% to 100%	Adults, Infants, Pediatrics (no motion ²): $\pm 2\%$ Neonates (no motion ²): $\pm 3\%$ Adults, Infants, Pediatrics, Neonates (motion ³): $\pm 3\%$ Adults, Infants, Pediatrics, Neonates (low perfusion ⁴): $\pm 2\%$
-------------	--

Resolution	1%
------------	----

Electrical/Optical Specifications	Masimo pulse oximetry uses multi-wavelength sensors that contain light-emitting diodes (LEDs) that emit visible light and infrared light at wavelengths from approximately 500 nm to approximately 1000 nm. The maximum radiant power of the strongest light is less than or equal to 25 mW. This information might be useful to clinicians, such as those performing photodynamic therapy.
-----------------------------------	---

Perfusion Index

Measurement range	0.1% to 20.0%
-------------------	---------------

Pulse rate

Unit of measure	beats per minute
-----------------	------------------

Measurement range	25 to 240 beats per minute
-------------------	----------------------------

Accuracy ⁵	Adults, Infants, Pediatrics, Neonates (no motion): ± 3 beats per minute Adults, Infants, Pediatrics, Neonates (motion): ± 5 beats per minute
-----------------------	---

Masimo specifications (for additional information, refer to the directions for use that accompanies each accessory)

	Adults, Infants, Pediatrics, Neonates (low perfusion ⁴): ± 3 beats per minute
Resolution	1 beat per minute

SpHb

Units of measure	g/dL, mmol/L; user-selectable
Measurement range	0.0 to 25.0 g/dL (0.0 to 15.5 mmol/L)
Accuracy ⁶	Adults, Pediatrics (no motion): 8 to 17 g/dL ± 1 g/dL
Resolution	0.1 g/dL or mmol/L

RRa

Unit of measure	breaths per minute
Body weight	Adult >66 pounds (30 kilograms)
Measurement range	0 to 70 breaths per minute
Accuracy ⁷	Adults: 4 to 70 ± 1 breath per minute
Resolution	1 breath per minute

¹ SpO₂ accuracy was determined by testing on healthy adult volunteers in the range of 60% to 100% SpO₂ against a laboratory CO-Oximeter. SpO₂ accuracy was determined on 16 neonatal NICU patients ranging in age from 7 to 135 days old and weighing between 0.5 and 4.25 kg. Seventy-nine (79) data samples were collected over a range of 70% to 100% SaO₂ with a resultant accuracy of 2.9% SpO₂. Contact Masimo for testing specifications.

² The Masimo sensors have been validated for no-motion accuracy in human blood studies on healthy adult male and female volunteers with light to dark skin pigmentation in induced hypoxia studies in the range of 70% to 100% SpO₂ against a laboratory CO-Oximeter and ECG monitor. This variation equals ± 1 standard deviation which encompasses 68% of the population.

³ The Masimo sensors have been validated for motion accuracy in human blood studies on healthy adult male and female volunteers with light to dark skin pigmentation in induced hypoxia studies while performing rubbing and tapping motions, at 2 to 4 Hz at an amplitude of 1 to 2 cm and a non-repetitive motion between 1 to 5 Hz at an amplitude of 2 to 3 cm in induced hypoxia studies in the range of 70% to 100% SpO₂ against a laboratory CO-Oximeter and ECG monitor. This variation equals ± 1 standard deviation which encompasses 68% of the population.

⁴ The Masimo rainbow SET CO-Oximeter module has been validated for low-perfusion accuracy in bench-top testing against a Fluke Biotek Index 2 simulator and Masimo's simulator with signal strengths of greater than 0.02% and transmission of greater than 5% for saturations and pulse rates within the stated accuracy specifications. This variation equals ± 1 standard deviation which encompasses 68% of the population.

⁵ The Masimo sensors have been validated for pulse rate accuracy for the range of 25 to 240 beats per minute in bench-top testing against a Biotek Index 2 simulator. This variation equals ± 1 standard deviation which encompasses 68% of the population.

⁶ SpHb accuracy has been validated on healthy adult male and female volunteers and on surgical patients with light to dark skin pigmentation in the range of 8 g/dL to 17 g/dL SpHb against a laboratory CO-Oximeter. The variation equals ± 1

Masimo specifications (for additional information, refer to the directions for use that accompanies each accessory)

standard deviation which encompasses 68% of the population. The SpHb accuracy has not been validated with motion or low perfusion.

⁷ Respiration rate accuracy for the RRa sensor and instrument has been validated for the range of 4 to 70 breaths per minute in bench-top testing. Clinical validation for up to 30 breaths per minute was also performed with the RRa sensor and instrument.

CO2 specifications (for additional information, refer to the directions for use that accompanies each accessory)

CO2 accuracy ^{1, 2, 3}	0 to 38 mmHg: ± 2 mmHg 39 to 150 mmHg: $\pm(5\%$ of reading + 0.08% for every 1 mmHg above 38 mmHg)
Flow rate	50 ($42.5 \leq \text{flow} \leq 65$) ml/min, flow measured by volume
Initialization time	40 seconds (typical, includes power-up and initialization time)
System response time	3.2 seconds (typical, includes module response time and host monitor system response time)
Compensation	The CO2 module is equipped with a barometric pressure transducer and compensation is triggered at startup or during other events (significant changes in temperature, ambient pressure, etc.). BTPS (standard correction used by Microstream capnography during all measurement procedures for body temperature, pressure, and saturation).
Cyclical pressure	≤ 10 kPa (100 cmH ₂ O); module operates within specification with overpressure up to 100 cmH ₂ O
Sampled gas return/disposal	Sampled gases are not returned to the breathing circuit. Exhaled gas is exhausted from the monitor's exhaust port. Dispose of sampled gases according to facility requirements or local regulations.
Calibration interval	Initial: After 1200 operating hours Subsequent: After 4000 operating hours or annually (whichever comes first)

Periodic service	After 30,000 operating hours
------------------	------------------------------

etCO2

Units of measure	mmHg, kPa; user-selectable
Display range	0 to 150 mmHg (0.0 to 20.0 kPa)
Resolution	1 mmHg, 0.1 kPa

FiCO2

CO₂ specifications (for additional information, refer to the directions for use that accompanies each accessory)

Units of measure	mmHg, kPa; user-selectable
Display range	0 to 150 mmHg (0.0 to 20.0 kPa)
Resolution	1 mmHg, 0.1 kPa

IPI

Display range	1 to 10
---------------	---------

RR

Unit of measure	breaths per minute
Display range	0 to 150 breaths per minute
Accuracy	0 to 70 breaths per minute: ± 1 breath per minute 71 to 120 breaths per minute: ± 2 breaths per minute 121 to 150 breaths per minute: ± 3 breaths per minute
Resolution	1 breath per minute

¹ The accuracy specification is maintained to within 4% of the values indicated in the presence of interfering gases in accordance with ISO 21647, clauses 51.101.3 and 101.1.

² The accuracy specification is maintained to within 4% of the values indicated in the presence of up to 80% helium with up to 15% oxygen when tested in accordance with ISO 21647.

³ The accuracy specification is maintained when tested for drift in accordance with ISO 21647, clause 51.101.2.

EarlySense specifications

Sensor

Dimensions	300mm x 210mm x 2.5mm
Weight	160 g
Material	Polycarbonate + ABS
Connector	RS232 (S11M03-P04M500-5260(ODU))

Sensor power supply

Electrical absolute maximum current, DC in	Minimum: -0.3V Maximum: 5.5V
Operating current	Minimum: 4.9V Typical: 5.0V Maximum: 5.2V

EarlySense specifications

Power consumption at 5V operating current Minimum: 1mA
Maximum: 4mA

Module

Dimensions 135mm x 75mm x 10mm

Weight 800 g

Host connection USB Mini-B

Module power supply

Electrical absolute maximum current, DC in Minimum: -0.3V
Maximum: 5.5V

Operating current Main power supply:
Minimum: 4.9V
Typical: 5.0V
RTC backup battery voltage:
Minimum: 2.5V
Typical: 3.0V
Maximum: 3.2V

Power consumption at 5V operating current Minimum: 4mA
Maximum: 400mA

Patient movement

Movement during defined period (1.5 minutes) 0 = 0%
L = Up to 40%
M = 40% to 60%
H = 60% to 80%
EH = 80% to 100%

Accuracy Adult:
0 = 100%, L = 100%, M = 81%, H = 100%, EH = 96%
Pediatric:
0 = 100%, L = 100%, M = 81%, H = 86%, EH = 94%

Averaging period 15 seconds

Respiration rate

Unit of measure breaths per minute

Measurement range 6 to 45 breaths per minute¹

Accuracy² ±4% or ±1.5 breaths per minute, whichever is greater

Averaging period 1 minute

EarlySense specifications

Pulse rate

Unit of measure	beats per minute
Measurement range	30 to 170 beats per minute ¹
Accuracy ²	±4% or ±5 beats per minute, whichever is greater
Averaging period	1 minute

¹ The system detects pulse rate that is > 1.8 times the respiration rate.

² Total system accuracy including undetected signals equals 90%.

Alarm limits	Upper limit range of entry	Lower limit range of entry
Systolic	Adult: 30 to 258 mmHg (4.0 to 34.4 kPa). Factory default: 220 mmHg (29.3 kPa). Pediatric: 32 to 160 mmHg (4.3 to 21.3 kPa). Factory default: 145 mmHg (19.3 kPa). Neonate: 27 to 120 mmHg (3.6 to 16.0 kPa). Factory default: 100 mmHg (13.3 kPa).	Adult: 28 to 256 mmHg (3.7 to 34.1 kPa). Factory default: 75 mmHg (10.0 kPa). Pediatric: 30 to 158 mmHg (4.0 to 21.1 kPa). Factory default: 75 mmHg (10.0 kPa). Neonate: 25 to 118 mmHg (3.3 to 15.7 kPa). Factory default: 50 mmHg (6.7 kPa).
Diastolic	Adult: 22 to 235 mmHg (2.9 to 31.3 kPa). Factory default: 110 mmHg (14.7 kPa). Pediatric: 17 to 130 mmHg (2.3 to 17.3 kPa). Factory default: 100 mmHg (13.3 kPa). Neonate: 12 to 105 mmHg (1.6 to 14.0 kPa). Factory default: 70 mmHg (9.3 kPa).	Adult: 20 to 233 mmHg (2.7 to 31.1 kPa). Factory default: 35 mmHg (4.7 kPa). Pediatric: 15 to 128 mmHg (2.0 to 17.1 kPa). Factory default: 35 mmHg (4.7 kPa). Neonate: 10 to 103 mmHg (1.3 to 13.7 kPa). Factory default: 30 mmHg (4.0 kPa).
MAP	Adult: 22 to 255 mmHg (2.9 to 34.0 kPa). Factory default: 120 mmHg (16.0 kPa). Pediatric: 17 to 140 mmHg (2.3 to 18.7 kPa). Factory default: 110 mmHg (14.7 kPa). Neonate: 12 to 110 mmHg (1.6 to 14.7 kPa). Factory default: 80 mmHg (10.7 kPa).	Adult: 20 to 253 mmHg (2.7 to 33.7 kPa). Factory default: 50 mmHg (6.7 kPa). Pediatric: 15 to 138 mmHg (2.0 to 18.4 kPa). Factory default: 50 mmHg (6.7 kPa). Neonate: 10 to 108 mmHg (1.3 to 14.4 kPa). Factory default: 35 mmHg (4.7 kPa).
SpO2	Adult, Pediatric, Neonate: 52% to 100%. Factory default: 100%.	Adult, Pediatric, Neonate: 50% to 98%. Factory default: 90%.
SpHb	Adult, Pediatric, Neonate: 1.5 to 24.5 g/dL (1.5 to 15.0 mmol/L). Factory default: 17.0 g/dL (11.0 mmol/L).	Adult, Pediatric, Neonate: 1.0 to 24.0 g/dL (1.0 to 14.5 mmol/L). Factory default: 7.0 g/dL (4.0 mmol/L).
Pulse rate (NIBP, SpO2)	Adult: 27 to 300 beats per minute. Factory default: 120 beats per minute. Pediatric: 27 to 300 beats per minute. Factory default: 150 beats per minute. Neonate: 27 to 300 beats per minute. Factory default: 200 beats per minute.	Adult: 25 to 298 beats per minute. Factory default: 50 beats per minute. Pediatric: 25 to 298 beats per minute. Factory default: 50 beats per minute. Neonate: 25 to 298 beats per minute. Factory default: 100 beats per minute.

Alarm limits	Upper limit range of entry	Lower limit range of entry
Pulse rate (EarlySense)	Adult, Pediatric: 37 to 150 beats per minute. Factory default: 130 beats per minute.	Adult: 35 to 148 beats per minute. Factory default: 40 beats per minute.
Temperature	Adult, Pediatric, Neonate: 87.1 to 110.0°F (30.6 to 43.3°C). Factory default: 101.0°F (38.3°C).	Adult, Pediatric, Neonate: 85.1 to 108.0°F (29.5 to 42.2°C). Factory default: 94.0°F (34.4°C).
etCO ₂	Adult: 2 to 150 mmHg (0.3 to 20.0 kPa). Factory default: 60 mmHg (8.0 kPa). Pediatric: 2 to 150 mmHg (0.3 to 20.0 kPa). Factory default: 60 mmHg (8.0 kPa). Neonate: 2 to 150 mmHg (0.3 to 20.0 kPa). Factory default: 50 mmHg (6.7 kPa).	Adult: 0 to 148 mmHg (0.0 to 19.7 kPa). Factory default: 15 mmHg (2.0 kPa). Pediatric: 0 to 148 mmHg (0.0 to 19.7 kPa). Factory default: 15 mmHg (2.0 kPa). Neonate: 0 to 148 mmHg (0.0 to 19.7 kPa). Factory default: 20 mmHg (2.7 kPa).
FiCO ₂	Adult: 0 to 150 mmHg (0.0 to 20.0 kPa). Factory default: 8 mmHg (1.1 kPa). Pediatric: 0 to 150 mmHg (0.0 to 20.0 kPa). Factory default: 8 mmHg (1.1 kPa). Neonate: 0 to 150 mmHg (0.0 to 20.0 kPa). Factory default: 5 mmHg (0.7 kPa).	None
IPI	None	Adult, Pediatric: 1 to 10. Factory default: 4.
RR (CO ₂)	Adult: 5 to 150 breaths per minute. Factory default: 50 breaths per minute. Pediatric: 5 to 150 breaths per minute. Factory default: 50 breaths per minute. Neonate: 5 to 150 breaths per minute. Factory default: 80 breaths per minute.	Adult: 0 to 145 breaths per minute. Factory default: 3 breaths per minute. Pediatric: 0 to 145 breaths per minute. Factory default: 3 breaths per minute. Neonate: 0 to 145 breaths per minute. Factory default: 12 breaths per minute.
RR (EarlySense)	Adult, Pediatric: 9 to 44 breaths per minute. Factory default: 32 breaths per minute.	Adult, Pediatric: 8 to 43 breaths per minute. Factory default: 8 breaths per minute.
RRa	Adult: 5 to 150 breaths per minute. Factory default: 50 breaths per minute.	Adult: 0 to 145 breaths per minute. Factory default: 3 breaths per minute.
Patient movement	Exit sensitivity: 1 to 6. Factory default: 3 EH > 1 minute	Off

Environmental specifications

Operating temperature	50°F to 104°F (10°C to 40°C)
Transport/storage temperature	-4°F to 122°F (-20°C to 50°C)
Operating altitude	-557 to 10,000 ft. (-170 m to 3,048 m)
Operating humidity	15 to 95% noncondensing
Transport/storage humidity	15% to 95% noncondensing

Monitor radio

The monitor's radio operates on Welch Allyn FlexNet™ or other 802.11 networks. For information regarding the configuration of network connections and recommended settings, see the best practices documents at www.welchallyn.com/promotions/Network_Installation_Best_Practices.htm.

Wireless network interface	IEEE 802.11 b/g, 802.11a
Frequency	802.11 b/g: 2.402 GHz to 2.4835 GHz 802.11a: 5.125 GHz to 5.875 GHz
Channels	Up to 14 in 802.11b/g, up to 24 in 802.11a; country-dependent
Security/encryption/authentication	WPA2/AES (either EAP or PSK authentication)
Antenna	Internal multiband PIFA
Wireless data rates	802.11b: 1Mbps or higher during vitals transmission only 802.11a/g: 6Mbps or higher during vitals transmission only (approximately 2 seconds per reading)
Agency approvals	US: FCC Part 15, Class B; C/UL; CE; 47 CFR Part 2.1093, 15.207, 15.209, 15.247, 15.407; FCC OET Bulletin 65C; FIPS 140-2 Level 1 (Connex VSM 6500 and 6800 series, and Connex IWS 8500 series) Europe: CE; EN 50371; EN/ETSI 300 328 V1.7.1, 301 489-1 V1.6.1, 301 489-17 V1.2.1, 301 893 V1.4.1 Canada: RSS-210; RSS-GEN; RSS-102 Hong Kong: HKTA 1039
Protocols	UDP, DHCP, TCP/IP
Data transfer protocols	UDP, TCP/IP
Modulation	OFDM (802.11a/g), DSSS/CCK (802.11b)
Output power	40mW typical, country-dependent
Ancillary IEEE standards	802.11e, 802.11h, 802.11i, 802.11X

Channel restrictions in the 5-GHz band are determined by country.

Marking by the symbol (!) indicates that usage restrictions apply. To ensure compliance with local regulations, be sure the correct country in which the access point is installed is selected. This product can be used with the following restriction(s):

France - Outdoor use is limited to 10 mW EIRP within the band 2454 to 2483.5 MHz.

Note Effective Isotropic Radiated Power (EIRP).

Note Some countries restrict the use of 5-GHz bands. The 802.11a radio in the monitor uses only the channels indicated by the access point with which the radio associates. The hospital IT department must configure access points to operate with approved domains.

Configuration options

Vital Signs Monitor 6000 Series

The monitor is available in multiple configurations.

Monitors capable of supporting a combination of NIBP, SpO2, SpHb, pulse rate, and temperature

Model	Description
6300	Basic. Includes USB and Ethernet connectivity.
6400	Standard. Includes nurse call, Ethernet, and USB connectivity. The radio is optional.
6500	Wireless. Includes all Standard features plus an internal 802.11 a/b/g radio.

Monitors capable of supporting a combination of CO2/RR or RRa or EarlySense (patient movement), NIBP, SpO2, SpHb, pulse rate, and temperature

Model	Description
6700	Standard. Includes nurse call, Ethernet, and USB connectivity. The radio is optional.
6800	Wireless. Includes all Standard features plus an internal 802.11 a/b/g radio.

Integrated Wall System

The wall system is available in the following configurations.

Model Prefix	Description
84 series	Standard. Includes nurse call, Ethernet, and USB connectivity.
85 series	Wireless. Includes all Standard features plus an internal 802.11 a/b/g radio.

Standards and compliance

General compliance and standards

The monitor complies with the following standards:

21 CFR Subchapter H – Medical Devices – US Food and Drug Administration
 2002 No. 236 – Australian Therapeutic Goods Act
 93/42/EEC – European Economic Community Medical Devices Directive
 2007/47/EC – European Economic Community Medical Devices Directive 2007
 Amendment
 94/62/EC – European Economic Community Packaging Directive
 2002/96/EC – European Economic Community Waste Electrical and Electronic
 Equipment Directive
 2006/66/EC – European Economic Community Batteries and Accumulators Directive
 SOR/98-282 – Canadian Medical Devices Regulation
 IATA DGR – International Air Transport Association Dangerous Goods Regulation
 United Nations ST/SG/AC.10/11 – Manual of Tests and Criteria, Part III, Sub-Section 38.3

ANSI/AAMI SP10
 AS/NZS 3200.1.0¹
 ASTM D 4332, E 1104
 CAN/CSA C22.2 NO.601.1¹ CAN/CSA-C22.2 NO.60601-1-2, CSA Z9919
 EN 1060-1, 1060-3, 1060-4²
 EN/IEC 60601-1, 60601-1-2, 60601-1-4, 60601-1-6, 60601-1-8, 60601-2-30, 60601-2-49,
 62304, 62366
 EN/ISO 9919, 13485, 14971, 21647
 ISTA 2A
 UL 60601-1¹



**Directive 2002/96/EC-WEEE:
 Disposal of noncontaminated electrical and electronic equipment**

This product and its accessories must be disposed of according to local laws and regulations. Do not dispose of this product as unsorted municipal waste. Prepare this product for reuse or separate collection as specified by Directive 2002/96/EC of the European Parliament and the Council of the European Union on Waste Electronic and

¹ Standard is essentially the IEC 60601-1 General standard plus the listed country's National Deviations.

² Non-Invasive Sphygmomanometers – Part 1: General Requirements, Part 3. Supplementary Requirements for Electro-Mechanical Blood Pressure Measuring Systems, Part 4: Test Procedures to Determine the Overall System Accuracy of Automated Non-Invasive Sphygmomanometers.

Electrical Equipment (WEEE). If this product is contaminated, this directive does not apply.

For more specific disposal or compliance information, see www.welchallyn.com/weee, or contact Welch Allyn Customer Service at +44 207 365 6780.

General radio compliance

The wireless features of this monitor must be used in strict accordance with the manufacturer's instructions as described in the user documentation that comes with the product.

This device complies with Part 15 of the FCC rules and with the rules of the Canadian ICES-003 as described below.

Federal Communications Commission (FCC)

This device complies with part 15 of the FCC Rules. Operation is subject to the following two conditions:

- This device may not cause harmful interference.
- This device must accept any interference received, including interference that may cause undesired operation.

This equipment has been tested and found to comply with the limits for a Class B digital device, pursuant to Part 15 of FCC Rules. These limits are designed to provide reasonable protection against harmful interference in a residential installation. This equipment generates, uses, and can radiate radio frequency energy. If not installed and used in accordance with the instructions, it may cause harmful interference to radio communications. However, there is no guarantee that interference will not occur in a particular installation. If this equipment does cause harmful interference to radio or television reception, which can be determined by turning the equipment off and on, the user is encouraged to try and correct the interference by one or more of the following measures:

- Reorient or relocate the receiving antenna
- Increase the distance between the equipment and the receiver
- Connect the equipment to an outlet on a circuit different from that to which the receiver is connected
- Consult the dealer or an experienced radio/TV technician for help

The user may find the following booklet prepared by the Federal Communications Commission helpful:

The Interference Handbook

This booklet is available from the U.S. Government Printing Office, Washington, D.C. 20402. Stock No. 004-000-0034504.

Welch Allyn is not responsible for any radio or television interference caused by unauthorized modification of the devices included with this Welch Allyn product, or the substitution or attachment of connecting cables and equipment other than specified by Welch Allyn.

The correction of interference caused by such unauthorized modification, substitution, or attachment will be the responsibility of the user.

Industry Canada (IC) emissions

This device complies with RSS 210 of Industry Canada.

Operation is subject to the following two conditions: (1) this device may not cause interference, and (2) this device must accept any interference, including interference that may cause undesired operation of this device.

L'utilisation de ce dispositif est autorisée seulement aux conditions suivantes: (1) il ne doit pas produire de brouillage et (2) l'utilisateur du dispositif doit être prêt à accepter tout brouillage radioélectrique reçu, même si ce brouillage est susceptible de compromettre le fonctionnement du dispositif.

This Class B digital apparatus complies with Canadian ICES-003.

Cet appareil numérique de la classe B est conforme à la norme NMB-003 du Canada.

European Union

Czech	Welch Allyn tímto prohlašuje, že tento RLAN device je ve shodě se základními požadavky a dalšími příslušnými ustanoveními směrnice 1999/5/ES.
Danish	Undertegnede Welch Allyn erklærer herved, at følgende udstyr RLAN device overholder de væsentlige krav og øvrige relevante krav i direktiv 1999/5/EF
Dutch	Bij deze verklaart Welch Allyn dat deze RLAN device voldoet aan de essentiële eisen en aan de overige relevante bepalingen van Richtlijn 1999/5/EC.
English	Hereby, Welch Allyn, declares that this RLAN device is in compliance with the essential requirements and other relevant provisions of Directive 1999/5/EC.
Estonian	Käesolevaga kinnitab Welch Allyn seadme RLAN device vastavust direktiivi 1999/5/EÜ põhinõuetele ja nimetatud direktiivist tulenevatele teistele asjakohastele sätetele.
Finnish	Welch Allyn vakuuttaa täten että RLAN device tyypinen laite on direktiivin 1999/5/EY oleellisten vaatimusten ja sitä koskevien direktiivin muiden ehtojen mukainen.
French	Par la présente, Welch Allyn déclare que ce RLAN device est conforme aux exigences essentielles et aux autres dispositions de la directive 1999/5/CE qui lui sont applicables
German	Hiermit erklärt Welch Allyn die Übereinstimmung des Gerätes RLAN device mit den grundlegenden Anforderungen und den anderen relevanten Festlegungen der Richtlinie 1999/5/EG. (Wien)
Greek	ΜΕ ΤΗΝ ΠΑΡΟΥΣΑ Welch Allyn ΔΗΛΩΝΕΙ ΟΤΙ RLAN device ΣΥΜΜΟΡΦΩΝΕΤΑΙ ΠΡΟΣ ΤΙΣ ΟΥΣΙΩΔΕΙΣ ΑΠΑΙΤΗΣΕΙΣ ΚΑΙ ΤΙΣ ΛΟΙΠΕΣ ΣΧΕΤΙΚΕΣ ΔΙΑΤΑΞΕΙΣ ΤΗΣ ΟΔΗΓΙΑΣ 1999/5/EK
Hungarian	Alulírott, Welch Allyn nyilatkozom, hogy a RLAN device megfelel a vonatkozó alapvető követelményeknek és az 1999/5/EC irányelv egyéb előírásainak.
Italian	Con la presente Welch Allyn dichiara che questo RLAN device è conforme ai requisiti essenziali ed alle altre disposizioni pertinenti stabilite dalla direttiva 1999/5/CE.
Latvian	Ar šo Welch Allyn deklarē, ka RLAN device atbilst Direktīvas 1999/5/EK būtiskajām prasībām un citiem ar to saistītajiem noteikumiem.
Lithuanian	Šiuo Welch Allyn deklaruoja, kad šis RLAN device atitinka esminius reikalavimus ir kitas 1999/5/EB Direktyvos nuostatas.

Malti	Hawnhekk, Welch Allyn, jiddikjara li dan RLAN device jikkonforma mal-htigijiet essenzjali u ma provvedimenti ohrajn relevanti li hemm fid-Dirrettiva 1999/5/EC
Portuguese	Welch Allyn declara que este RLAN device está conforme com os requisitos essenciais e outras disposições da Directiva 1999/5/CE.
Slovak	Welch Allyn týmto vyhlasuje, že RLAN device spĺňa základné požiadavky a všetky príslušné ustanovenia Smernice 1999/5/ES.
Slovene	Šiuo Welch Allyn deklaruoja, kad šis RLAN device atitinka esminius reikalavimus ir kitas 1999/5/EB Direktyvos nuostatas.
Spanish	Por medio de la presente Welch Allyn declara que el RLAN device cumple con los requisitos esenciales y cualesquiera otras disposiciones aplicables o exigibles de la Directiva 1999/5/CE
Swedish	Härmed intygar Welch Allyn att denna RLAN device står i överensstämmelse med de väsentliga egenskapskrav och övriga relevanta bestämmelser som framgår av direktiv 1999/5/EG.

Guidance and manufacturer's declaration

EMC compliance

Special precautions concerning electromagnetic compatibility (EMC) must be taken for all medical electrical equipment. This device complies with IEC EN 60601-1-2:2007.

- All medical electrical equipment must be installed and put into service in accordance with the EMC information provided in this document and the *Welch Allyn Connex Vital Signs Monitor 6000 Series Directions for Use*.
- Portable and mobile RF communications equipment can affect the behavior of medical electrical equipment.

The monitor complies with all applicable and required standards for electromagnetic interference.

- It does not normally affect nearby equipment and devices.
- It is not normally affected by nearby equipment and devices.
- It is not safe to operate the monitor in the presence of high-frequency surgical equipment.
- However, it is good practice to avoid using the monitor in extremely close proximity to other equipment.

Emissions and immunity information

For information about electromagnetic compatibility (EMC), see the Welch Allyn website:

http://www.welchallyn.com/apps/products/product_category.jsp?catcode=PMS

Appendix

Approved accessories

The following tables list approved monitor and wall system accessories and documentation. For information about options, upgrades, and licenses, refer to the service manual.

FlexiPort cuffs (not made with natural rubber latex)

Part Number	Model	Description
Reuse-08-2MQ	Reusable	Cuff, reuse, SM CHILD, 2-tube, MQ
Reuse-09-2MQ	Reusable	Cuff, reuse, CHILD, 2-tube, MQ
Reuse-10-2MQ	Reusable	Cuff, reuse, SM AD, 2-tube, MQ
Reuse-11-2MQ	Reusable	Cuff, reuse, ADULT, 2-tube, MQ
Reuse-11L-2MQ	Reusable	Cuff, reuse, AD LONG, 2-tube, MQ
Reuse-12-2MQ	Reusable	Cuff, reuse, LG AD, 2-tube, MQ
Reuse-12L-2MQ	Reusable	Cuff, reuse, LG AD LONG, 2-tube, MQ
Reuse-13-2MQ	Reusable	Cuff, reuse, THIGH, 2-tube, MQ
Soft-07-2MQ	Disposable	Cuff, soft, INFANT, 2-tube, MQ (box of 20)
Soft-08-2MQ	Disposable	Cuff, soft, SM CHILD, 2-tube, MQ (box of 20)
Soft-09-2MQ	Disposable	Cuff, soft, CHILD, 2-tube, MQ (box of 20)
Soft-10-2MQ	Disposable	Cuff, soft, SM AD, 2-tube, MQ (box of 20)
Soft-11-2MQ	Disposable	Cuff, soft, ADULT, 2-tube, MQ (box of 20)
Soft-11L-2MQ	Disposable	Cuff, soft, AD LONG, 2-tube, MQ (box of 20)
Soft-12-2MQ	Disposable	Cuff, soft, LG AD, 2-tube, MQ (box of 20)
Soft-12L-2MQ	Disposable	Cuff, soft, LG AD LONG, 2-tube, MQ (box of 20)

Part Number	Model	Description
Soft-13-2MQ	Disposable	Cuff, soft, THIGH, 2-tube, MQ (box of 20)
5082-101-1	Disposable	Neo-1 disposable cuff, male luer connector (box of 10 cuffs)
5082-102-1	Disposable	Neo-2 disposable cuff, male luer connector (box of 10 cuffs)
5082-103-1	Disposable	Neo-3 disposable cuff, male luer connector (box of 10 cuffs)
5082-104-1	Disposable	Neo-4 disposable cuff, male luer connector (box of 10 cuffs)
5082-105-1	Disposable	Neo-5 disposable cuff, male luer connector (box of 10 cuffs)

Blood pressure accessories (not made with natural rubber latex)

Part Number	Model	Description
4500-30	SureBP	Double tube blood pressure hose (5 ft)
4500-31	SureBP	Double tube blood pressure hose (10 ft)
4500-32	SureBP	Double tube blood pressure hose (8 ft)
6000-30	BP	Single tube blood pressure hose (5 ft)
6000-31	BP	Single tube blood pressure hose (10 ft)
6000-33	BP	Neonatal blood pressure hose (10 ft)

Masimo pulse oximetry (for use with devices with SpO2)

Part Number	Model	Description
LNCS-DCI	LNCS	Reusable finger sensor - Adult
LNCS-DCIP	LNCS	Reusable finger sensor - Pediatric
LNCS-ADTX	LNCS	Disposable adhesive finger sensor - Adult (20 per case)
LNCS-PDTX	LNCS	Disposable adhesive finger sensor - Pediatric (20 per case)
RED-LNC-10	LNCS	10-foot cable with sensor connector
LNCS-YI	LNCS	Multisite reusable sensor (1 sensor, 6 adhesive wraps)
LNCS-TC-I	LNCS	Reusable ear sensor
LNCS-Neo-L-3	LNCS	Disposable adhesive finger sensor - Neonate/Adult (20 per case)
Neo-Wrap-RP	LNCS	Replacement wrap for neonatal adhesives (100 per case)
LNCS-Inf-3	LNCS	Disposable adhesive finger sensor - Infant (20 per case)

Part Number	Model	Description
Inf-Wrap-RP	LNCS	Replacement wrap for infant adhesives (100 per case)
YI-AD	LNCS	Multisite adhesive wrap adult/pediatric/neonatal for YI sensor (100 per case)
YI-FM	LNCS	Multisite foam wrap adult/pediatric/neonatal for YI sensor (12 per case)

Masimo rainbow set (for use with devices with SpO2 and SpHb)

Part Number	Model	Description
104220	rainbow	DCI SC-360 Adult SpHb sensor and 3-foot cable
104360	rainbow	ReSposable R2-25 sample pack
104149	rainbow	RC-12, 12-foot extension cable, 20 pin, for M-LNCS sensors

Masimo RRa

Part Number	Model	Description
104770	rainbow	Dual cable
104771	rainbow	RAS-125 sensor (box of 10)
104772	rainbow	Patient cable
104850	rainbow	RRa accessories kit

Nellcor pulse oximetry

Part Number	Model	Description
DS-100A	OxiMax	Durasensor adult oxygen transducer
DOC-10	OxiMax	Extension cable (10 feet)
D-YS	OxiMax	Dura-Y oxygen transducer (1 sensor, 40 wraps)
D-YSE	OxiMax	Ear clip (use with Dura-Y sensor)
D-YSPD	OxiMax	PediCheck pediatric spot check (use with Dura-Y sensor)
MAX-AI	OxiMax	OxiMax adult sensor (single use, case of 24)
MAX-PI	OxiMax	OxiMax pediatric sensor (single use, case of 24)
MAX-II	OxiMax	OxiMax infant sensor (single use, case of 24)

Part Number	Model	Description
OXI-A/N	OxiMax	Oxiband adult/neonatal transducer (1 sensor, 50 wraps)
OXI-P/I	OxiMax	Oxiband pediatric/infant transducer (1 sensor, 50 wraps)

SureTemp Plus thermometry

Part Number	Description
02895-000	Oral probe and well kit (9ft., 2.7M)
02895-100	Rectal probe and well kit (9ft., 2.7M)
02894-0000	Oral probe well (blue)
02894-1000	Rectal probe well (red)
05031-101	Disposable probe covers (1,000 covers, packaged 25/box)
05031-110	Disposable probe covers (10,000 covers, packaged 25/box)
01802-110	9600 Plus calibration tester
06138-000	Temperature calibration key

Braun ThermoScan PRO 4000 thermometer and accessory dock

Part Number	Description
04000-900	Dock with thermometer
36000	Dock without thermometer
86100	Wall mount kit
86200	Mobile stand kit

EarlySense RR, pulse rate, and patient movement

Part Number	Description
105481	Contact-free sensor
MSH-00033	Metallic plate for beds
MSH-00033A	Metallic plate for beds with .78" length hooks for spring pan bed frames
MSH-00033B	Metallic plate for beds with 1.18" length hooks for spring pan bed frames

Part Number	Description
AME-00970	Bed sensor wall mount hanger
105637	Pigtail cable

Oridion CO2

Oridion Microstream etCO₂ filter lines (sampling lines) are the only accessories approved by Welch Allyn for CO₂ monitoring. They are available only from Oridion. To find an Oridion distributor, please refer to www.oridion.com.

Physical assessment instruments

Part Number	Description
Otoscopes	
23810	MacroView™ otoscope
23820	MacroView™ otoscope with throat illuminator
23814	MacroView™ otoscope with insufflation bulb
23824	MacroView™ otoscope with throat illuminator and insufflation bulb
25020	Diagnostic otoscope with specula
25021	Diagnostic otoscope with insufflation bulb
20201	Pneumatic otoscope without specula
20200	3.5V pneumatic otoscope with specula
20250	3.5V pneumatic otoscope with 12-diopter lens and specula
20251	Pneumatic otoscope with 12-diopter lens
21700	3.5V operating otoscope with specula
21701	3.5V operating otoscope without specula
Specula and specula dispensers	
52432-U	2.75 mm Universal KleenSpec® disposable ear specula (case of 10 bags, 850/bag)
52434-U	4.25 mm Universal KleenSpec® disposable ear specula (case of 10 bags, 850/bag)
52100-PF	Dispenser (full), large ear specula
52400-PF	Dispenser (full), small ear specula

Part Number	Description
Ophthalmoscopes	
11810	Panoptic ophthalmoscope
11820	Panoptic ophthalmoscope with cobalt blue filter and add-on corneal viewing lens
11710	Standard ophthalmoscope
11720	Coaxial ophthalmoscope
11730	AutoStep® coaxial ophthalmoscope
11735	Prestige coaxial-plus ophthalmoscope
Illuminators	
41100	Finnoff ocular transilluminator
41101	Finnoff ocular transilluminator with cobalt blue filter
43300	Curved all-purpose transilluminator
26535	Nasal illuminator (section only)
26538	Complete nasal illuminator
26035	Bivalve nasal speculum
26038	Bivalve nasal speculum with illuminator
27000	Larynx illuminator
27050	Nasopharynx illuminator
28100	Tongue blade holder
Lamps	
03100-LED	LED replacement lamp
06500-LED	LED replacement lamp
04900-LED	LED replacement lamp
03800-LED	LED replacement lamp
03100-U	Halogen replacement lamp
06500-U	Halogen replacement lamp
04900-U	Halogen replacement lamp
03800-U	Halogen replacement lamp

Mounting options

Part Number	Description
4800-60	Accessory Cable Management (ACM) stand — organized mobile stand with bin, standard housing
4900-60	Accessory Cable Management (ACM) stand — organized mobile stand with bin, extended housing
104645	Mounting plate (bracket), ACM mobile stand, extended housing
4700-60	Economy mobile stand with basket, standard housing
4701-62	Wall mount with basket, standard housing
008-0834-01	GCX wall mount with channel, standard housing
4900-62	GCX wall mount with channel, extended housing
104644	Mounting plate (bracket), GCX wall mount, extended housing

Weight scales and connectivity kits

For a list of approved weight scales and connectivity kits, go to www.welchallyn.com.

Miscellaneous items

Part Number	Description
BATT99	Lithium-ion battery 9 cell — Extended life
6000-101H	Carrying case, hard sided
6000-100S	Carrying case, soft sided
6000-40	Printer paper (10 per pack)
PWCD-B	Line cord B, North America
PWCD-2	Line cord 2, Europe, 8'
PWCD-4	Line cord 4, United Kingdom, 8'
PWCD-6	Line cord 6, Australia/New Zealand, 8'
PWCD-7	Line cord 7, South Africa, 8'
6000-NC	Nurse Call cable
6000-916	1900 2D barcode scanner
6000-915HS	HS1-M 2D barcode scanner with coiled USB

Part Number	Description
6000-910	Mounting arm for HS1-M Barcode scanner (use with Economy mobile stand with basket only)
4500-925	Cable for wired connectivity
660-0320-00	Patch cable, 100', RJ45 M/M CAT5E
660-0321-00	Patch cable, 50', RJ45 M/M CAT5E
104384	Patch cable, 25', green
660-0138-00	Patch cable, 5', RJ45 T568B
715270	Box set — packaging — empty
104279	Connex IWS shipping box
6000-50	USB configuration memory stick

Service, Vital Signs Monitor 6000 Series

Part Number	Description
S1-6000	Comprehensive partnership program, 1 year
S1-6000-C	Comprehensive partnership program, 1 year, with calibration
S1-6000-2	Comprehensive partnership program, 2 years
S1-6000-2C	Comprehensive partnership program, 2 years, with calibration
S1-6000-5	Comprehensive partnership program, 5 years
S1-6000-5C	Comprehensive partnership program, 5 years, with calibration
S1-6000-02	Comprehensive partnership program, 1 year, with CO2
S1-6000-02-2	Comprehensive partnership program, 2 years, with CO2
S1-6000-02-5	Comprehensive partnership program, 5 years, with CO2
S1-6000-02-C	Comprehensive partnership program, 1 year, with CO2, with calibration
S1-6000-02-2C	Comprehensive partnership program, 2 years, with CO2, with calibration
S1-6000-02-5C	Comprehensive partnership program, 5 years, with CO2, with calibration
S1-6000-ES	Comprehensive partnership program, 1 year, with EarlySense
S1-6000-ES-2	Comprehensive partnership program, 2 years, with EarlySense
S1-6000-ES-5	Comprehensive partnership program, 5 years, with EarlySense

Part Number	Description
S1-6000-ES-C	Comprehensive partnership program, 1 year, with EarlySense and calibration
S1-6000-ES-2C	Comprehensive partnership program, 2 years, with EarlySense and calibration
S1-6000-ES-5C	Comprehensive partnership program, 5 years, with EarlySense and calibration
S2-6000	Biomed partnership program, 1 year
S2-6000-2	Biomed partnership program, 2 years
S2-6000-5	Biomed partnership program, 5 years
S2-6000-02	Biomed partnership program, 1 year, with CO2
S2-6000-02-2	Biomed partnership program, 2 years, with CO2
S2-6000-02-5	Biomed partnership program, 5 years, with CO2
S2-6000-ES	Biomed partnership program, 1 year, with ES
S2-6000-ES-2	Biomed partnership program, 2 years, with ES
S2-6000-ES-5	Biomed partnership program, 5 years, with ES
PRV-ESS	Preventive annual sensor replacement program (selected countries)
PRV-001	Preventive Welch Allyn bench service, per unit (selected countries)
PRV-002	Preventive onsite service, per unit (selected countries)
S4-6000	CVSM, Warranty extension, 1 year (selected countries)
S4-6000-2	CVSM, Warranty extension, 2 years (selected countries)
S4-6000-5	CVSM, Warranty extension, 5 years (selected countries)
S4-6000-02	CVSM with CO2, Warranty extension, 1 year (selected countries)
S4-6000-02-2	CVSM with CO2, Warranty extension, 2 years (selected countries)
S4-6000-02-5	CVSM with CO2, Warranty extension, 5 years (selected countries)
S4-6000-ES	CVSM with EarlySense, Warranty extension, 1 year (selected countries)
S4-6000-ES-2	CVSM with EarlySense, Warranty extension, 2 years (selected countries)
S4-6000-ES-5	CVSM with EarlySense, Warranty extension, 5 years (selected countries)

Service, Integrated Wall System

Part Number	Description
103371	Barcode license
Partnership Programs for Global Use	
S1-CIWS	One-year Comprehensive Partnership Program
S1-CIWS-2	Two-year Comprehensive Partnership Program
S2-CIWS	One-year Biomed Partnership Program
S2-CIWS-2	Two-year Biomed Partnership Program
Technical Training	
CIWSSERREPW-TRN	Technical online training for Biomed
CIWSSERREP-TRN	Technical onsite training for Biomed
International Only	
PRV-001	Preventive SVC WA bench per unit
PRV-002	Preventive SVC planned onsite per unit
S4-CIWS	One-year Extended Warranty
S4-CIWS-2	Two-year Extended Warranty

Literature/Documentation, Vital Signs Monitor 6000 Series

Part Number	Description
106101	CD, Directions for Use, Service Manuals, English
4600-90E	Blood Pressure Accuracy and Variability Card, English
6000-150E	In-service CD
Directions for Use	
80019390	Directions for Use, printed copy, English
Quick Reference Cards	
5 configuration-specific cards: Base set, CO2, RRa, Connectivity, EarlySense	
104703	Quick Reference Card, Base set, English
105347	Quick Reference Card, CO2, English
105348	Quick Reference Card, RRa, English
105349	Quick Reference Card, Connectivity, English
105640	Quick Reference Card, EarlySense, English
Service Manual	
80019391	Service Manual, English
Directions for Use, ACM Mobile Stand	
4800-60	Directions for Use, Accessory Cable Management (ACM) Mobile Stand

Literature/Documentation, Integrated Wall System

Part Number	Description
106101	CD, Directions for Use, Service Manuals, English
4600-90E	Blood Pressure Accuracy and Variability Card-English
Directions for Use	
80019390	Directions for Use, printed copy, English
Quick Reference Card	
104067	Quick Reference Card, Connex Integrated Wall System, English
Service Manual (English only)	

Part Number	Description
80019392	Service Manual, Connex Integrated Wall System, English

Warranty

Vital Signs Monitor 6000 Series

Welch Allyn warrants the product to be free of defects in material and workmanship and to perform in accordance with manufacturer's specifications for the period of two years from the date of purchase from Welch Allyn or its authorized distributors or agents.

The warranty period shall start on the date of purchase. The date of purchase is: 1) the invoiced ship date if the device was purchased directly from Welch Allyn, 2) the date specified during product registration, 3) the date of purchase of the product from a Welch Allyn authorized distributor as documented from a receipt from said distributor.

This warranty does not cover damage caused by: 1) handling during shipping, 2) use or maintenance contrary to labeled instructions, 3) alteration or repair by anyone not authorized by Welch Allyn, and 4) accidents.

The product warranty is also subject to the following terms and limitations: Accessories are not covered by the warranty. Refer to the directions for use provided with individual accessories for warranty information.

Shipping cost to return a device to a Welch Allyn Service center is not included.

A service notification number must be obtained from Welch Allyn prior to returning any products or accessories to Welch Allyn's designated service centers for repair. To obtain a service notification number, contact Welch Allyn Technical Support.

THIS WARRANTY IS IN LIEU OF ALL OTHER WARRANTIES, EXPRESS OR IMPLIED, INCLUDING BUT NOT LIMITED TO THE IMPLIED WARRANTIES OF MERCHANTABILITY AND FITNESS FOR A PARTICULAR PURPOSE. WELCH ALLYN'S OBLIGATION UNDER THIS WARRANTY IS LIMITED TO REPAIR OR REPLACEMENT OF PRODUCTS CONTAINING A DEFECT. WELCH ALLYN IS NOT RESPONSIBLE FOR ANY INDIRECT OR CONSEQUENTIAL DAMAGES RESULTING FROM A PRODUCT DEFECT COVERED BY THE WARRANTY.

Integrated Wall System

Welch Allyn warrants the product to be free of defects in material and workmanship and to perform in accordance with manufacturer's specifications for the period of one year from the date of purchase from Welch Allyn or its authorized distributors or agents. The coiled cords carry a special 10-year warranty against breakage during normal usage.

The warranty period shall start on the date of purchase. The date of purchase is: 1) the invoiced ship date if the device was purchased directly from Welch Allyn, 2) the date specified during product registration, 3) the date of purchase of the product from a Welch Allyn authorized distributor as documented from a receipt from said distributor.

This warranty does not cover damage caused by: 1) handling during shipping, 2) use or maintenance contrary to labeled instructions, 3) alteration or repair by anyone not authorized by Welch Allyn, and 4) accidents.

The product warranty is also subject to the following terms and limitations: Accessories are not covered by the warranty. Refer to the directions for use provided with individual accessories for warranty information.

A service notification number must be obtained from Welch Allyn prior to returning any products or accessories to Welch Allyn's designated service centers for repair. To obtain a service notification number, contact Welch Allyn Technical Support.

THIS WARRANTY IS IN LIEU OF ALL OTHER WARRANTIES, EXPRESS OR IMPLIED, INCLUDING BUT NOT LIMITED TO THE IMPLIED WARRANTIES OF MERCHANTABILITY AND FITNESS FOR A PARTICULAR PURPOSE. WELCH ALLYN'S OBLIGATION UNDER THIS WARRANTY IS LIMITED TO REPAIR OR REPLACEMENT OF PRODUCTS CONTAINING A DEFECT. WELCH ALLYN IS NOT RESPONSIBLE FOR ANY INDIRECT OR CONSEQUENTIAL DAMAGES RESULTING FROM A PRODUCT DEFECT COVERED BY THE WARRANTY.

