

Digital MacroView™ Otoscope



Directions for Use

WelchAllyn®
Advancing Frontline Care™

Copyright 2008 Welch Allyn. All rights are reserved. No one is permitted to reproduce or duplicate, in any form, this manual or any part thereof without permission from Welch Allyn.

Caution: Federal law restricts this device to sale by or on the order of a licensed professional trained in otoscopy.

Welch Allyn assumes no responsibility for any injury, or for any illegal or improper use of the product, that may result from failure to use this product in accordance with the instructions, cautions, warnings, or indications for use published in this manual.

Welch Allyn is a registered trademark of Welch Allyn, Inc. Digital Macroview is a trademark of Welch Allyn, Inc.

Software in this product is copyright Welch Allyn or its vendors. All rights are reserved. The software is protected by United States of America copyright laws and international treaty provisions applicable worldwide. Under such laws, the licensee is entitled to use the copy of the software incorporated with this instrument as intended in the operation of the product in which it is embedded. The software may not be copied, decompiled, reverse-engineered, disassembled or otherwise reduced to human-perceivable form. This is not a sale of the software or any copy of the software; all right, title, and ownership of the software remain with Welch Allyn or its vendors.

Caution: Changes or modifications not expressly approved by Welch Allyn could void the purchaser's authority to operate the equipment.

For information about any Welch Allyn product, call Welch Allyn Technical Support:

USA + 1 315 685 4560 800 535 6663	Australia + 61 29 638 3000
Canada 800 561 8797	China + 86 216 327 9631
European Call Center + 353 46 906 7790	France + 331 6009 3366
Germany + 49 747 792 7186	Japan + 81 33 219 0071
Latin America + 1 305 669 9003	Netherlands + 31 15 750 5000
Singapore + 65 6419 8100	South Africa + 27 11 777 7555
United Kingdom + 44 207 365 6780	Sweden + 46 85 853 6551

Reorder No. 23920MAN/23960MAN

80012182 Ver. F

Printed in USA

Welch Allyn
4341 State Street Road,
PO Box 220
Skaneateles Falls, NY
13153-0220
www.welchallyn.com



European Regulatory Manager
Welch Allyn Ltd.
Navan Business Park
Dublin Road
Navan, County Meath,
Republic of Ireland
Tel.: +353 46 90 67700
Fax: +353 46 90 67755

CE WelchAllyn®

Contents

1	Introduction	1
	System Requirements	1
	Intended use	1
	User Profile	1
	Symbols	2
	Warnings and cautions	4
2	Operation	7
	Using the otoscope head	7
	Setup	8
	Using the Digital MacroView System	8
	Using focus	9
	Using the controls	10
	Reviewing images	11
	Standby Mode	12
	Using the throat illuminator	13
3	Maintenance and service	15
	Replacing the lamp	15
	Cleaning recommendation	16
	Recycling the system components	17
	Accessories	18
	Service policy	19
4	Specifications	21
	Limited Warranty	23

1 Introduction

The Digital MacroView System consists of a digital otoscope head and a USB Video Cable. A 3.5 volt Welch Allyn power source and a computer are necessary to use the Digital MacroView System.

The Digital MacroView System is designed for "Plug and Play" operation - all adjustments including illumination and white balance are pre-set at the factory.

System Requirements

The Digital MacroView requires a user device running Windows XP Service Pack 2 or later operating system, a viewing screen, and a USB 2.0 port.

Intended use

The otoscope is intended to allow inspection of the external ear, ear canal, and tympanic membrane under magnification. A secondary use of the otoscope may be for assessing the flexibility of the tympanic membrane (pneumatic otoscopy).

User Profile

The Digital MacroView is intended for licensed professionals trained in otoscopy.

Symbols

Safety Symbols



WARNING



Caution



Caution: Consult accompanying documentation

IPX0

Not protected from the ingress of water



Type BF



Temperature limits



USB



Relative humidity limit



Recycle the product separate from other disposables. See "Recycling the system components" on page 17.

Button Symbols



Capture Image



Zoom

Agency Symbols



CERTIFIED TO:
CAN/CSA STD C22.2 NO. 601.1

CONFORMS TO:
UL STD 60601-1

IEC 60601-1



The CE mark on this product indicates that it has been tested to and conforms with the provisions noted within the 93/42/EEC Medical Device Directive.



European Regulatory Manager
Welch Allyn Ltd.
Navan Business Park • Dublin Road • Navan, County Meath,
Republic of Ireland
Tel.: +353 46 90 67700 • Fax: +353 46 90 67755

Warnings and cautions

Familiarize all operating personnel with the general safety information in this summary. Specific warnings and cautions are also found throughout this manual. Such specific warnings and cautions may not appear here in this summary.

Warnings

A warning statement in this manual identifies a condition or practice, which if not corrected or discontinued immediately, could lead to injury, illness, or death.



WARNING Do not use in the presence of flammable anesthetics.

WARNING This product has no user serviceable/replaceable parts except for the lamp. Please refer all other service to authorized service personnel.

WARNING This instrument is not intended to be used in the eye.

WARNING This product generates and records reference images from inputs obtained from the Welch Allyn Digital Macroview. These reference images are not intended for diagnostic purposes.

Cautions

A caution statement in this manual identifies a condition or practice, which if not corrected or discontinued immediately, could lead to equipment failure, equipment damage, or data loss.



Caution In order to obtain optimum performance and ensure patient safety, thoroughly read this booklet.

Caution The Digital MacroView System is designed expressly for use with an approved Welch Allyn 3.5v power source. Damage to the system will occur if alternate power sources are attached to the video head.

Caution Do not use the Digital MacroView if you notice any signs of damage to the components of the system. Contact Customer Service Department for immediate assistance.

Caution Before each use, the outer surface of the ear specula on the Digital MacroView which is intended to be inserted into a PATIENT should be checked to ensure there are no unintended rough surfaces, sharp edges or protrusions which may Cause a SAFETY HAZARD.

Caution Do not attempt to disinfect the Digital MacroView System using glutaraldehyde products, ethylene oxide gas, steam or any other liquid or gas disinfectant.

Caution The signal output (USB Port) connector is intended for connection of only devices complying with IEC 60601-1, or other IEC standards (for example, IEC 60950), as appropriate to the device. Connecting additional devices to the Digital MacroView System is configuring a medical system and you are responsible for verifying that the system complies with the requirements of the system standard IEC 60601-1-1.



Caution This product complies with current required standards for electromagnetic interference and should not present problems to other equipment or be affected by other devices. As a precaution, avoid using this device in close proximity to other equipment.

Caution To minimize external otoscope housing temperatures, on-time should not exceed 2 minutes and off-time a minimum of 10 minutes.

Caution Only accepts Welch Allyn specula.

Caution Use only Welch Allyn approved lamps.

Caution Do not apply alcohol, chemicals, or water to the lenses. Solution entering the optical assembly could damage internal components.

2 Operation

Using the otoscope head

Align the cutouts in the otoscope head base with power source lugs. Push down slightly and turn 90° clockwise. To remove, reverse this procedure. The otoscope head fits all 3.5v Welch Allyn power sources.

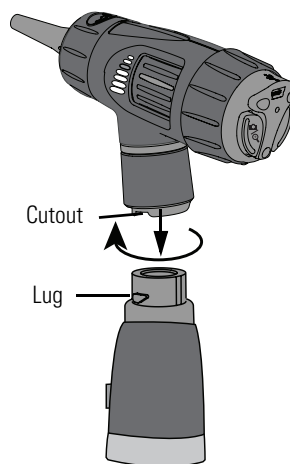

Caution Only accepts Welch Allyn specula.

Attach: Twist the specula clockwise until it clicks into the locked position.

Remove: Turn the TipGrip or twist the specula counterclockwise.

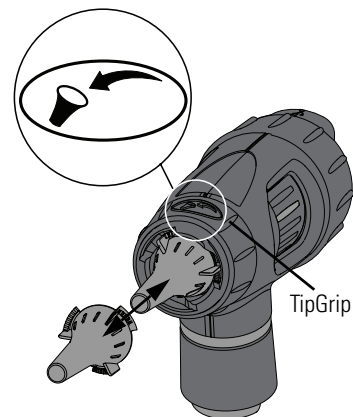

Setup

Prior to using the Digital MacroView for the first time, install the Welch Allyn Viewer Utility following the instructions provided with the Viewer CD.

Using the Digital MacroView System

1. Verify the power source is off and attach the Welch Allyn Digital MacroView head to the power source ([see page 7](#)).
2. Connect the USB cable to the port on the back of the Digital MacroView head and to the computer USB port. The computer gives an audible signal that the connection is complete.

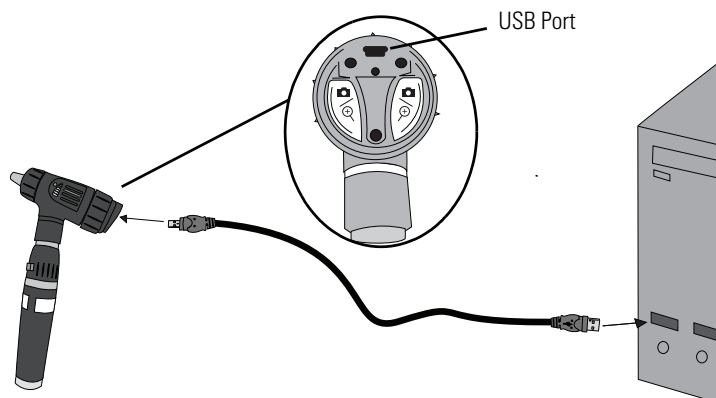

3. Double-click the Welch Allyn Viewer icon on your computer desktop.

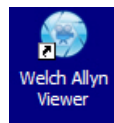

4. Turn the power source to FULL ON position to achieve optimum performance. The computer displays an image. Digital MacroView automatically optimizes the image brightness.

If necessary, adjust the color and brightness controls on the computer monitor for picture quality.

Using focus

Default Position: align the green line to the green dot.

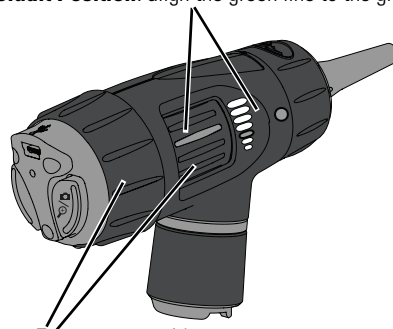

Free Focus: rotate either wheel to fine-tune the image.

Using the controls

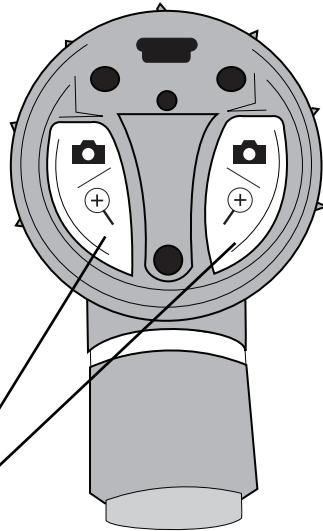

Capture:  Press and hold **either** function button for approximately 1 second. Upon *release* of the function button the *image freezes* as a thumbnail on the screen. If the image is rotated (see below) then the captured image is rotated.

Zoom:  Press and hold **either** function button for approximately 2 seconds. Zoom is for on-screen viewing purposes only. Capturing an image while in zoom mode produces a standard thumbnail. Press and hold **either** function button again to zoom out.

Rotate: Press and hold **both** buttons for approximately 4 seconds. Image rotates 180° on screen. Press and hold again to return the image to its original position.

Reviewing images

Snapshot: Click to take a snapshot from the viewer. Image displays as a thumbnail on the screen.

Record Video Clip: Click to start recording (green icon); click again to stop recording (blue icon). Video clip displays as a thumbnail on the screen and marked as Video.
NOTE: You must have a video recorder such as Windows Movie Maker or Windows Media Player installed on your computer.

View Full Screen: Click to view full screen. Press ESC to return to the normal view.

Settings:
Default Directory: Click Browse and select the file path where you want to save your images.
Video Clip Length: Select Video Capture Limit and select an option. Two minutes is the maximum allowable length of a recorded video.
Default File Format: Select an available file type for your graphics.

Save All Images/Videos: Select Yes. To save a single image/video: Right-click the thumbnail and select Clear. Answer Yes.

Clear All Images/Videos: Select Yes. To clear a single image/video: Right-click the thumbnail and select Clear. Answer Yes.

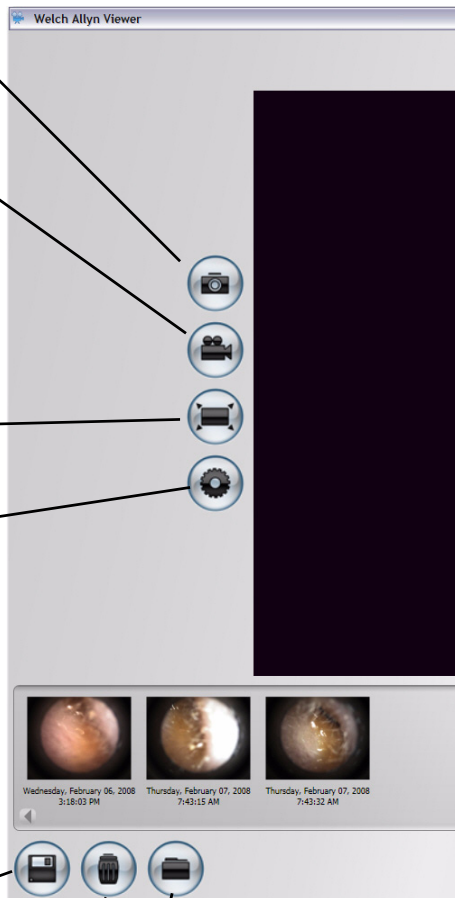

View Saved Images/Videos: Window displays default directory for storage. Select the file or select another directory or folder to locate the desired file. Double-click on the file name to view the image.

Standby Mode

The Digital MacroView shuts down the active viewing window after approximately 12 hours of continuous connection to the active viewing window and computer.

To restart the Digital MacroView:

1. Press either function button and re-open Windows Explorer.
2. Open Windows Explorer and click **My Computer** in the left pane. Double-click the **USB Video Device**.

Or double-click the **My Computer** icon on your computer desktop and double-click the **USB Video Device**.

Using the throat illuminator

The Welch Allyn Digital MacroView can transform into a throat illuminator. While using the throat illuminator there are no images available on screen or for capture.



WARNING It is important to note that while the throat illuminator section provides an excellent source of general illumination, avoid more than momentary direct skin contact due to possible heat build up.

1. Grasp the otoscope section with the left hand.
2. Grasp the throat illuminator's collar at (under the silver ring).
3. Hold the throat illuminator collar stationary, twist the otoscope section counterclockwise until the otoscope head is removed.

To replace otoscope section, align the otoscope section with the top of the throat illuminator and turn clockwise.

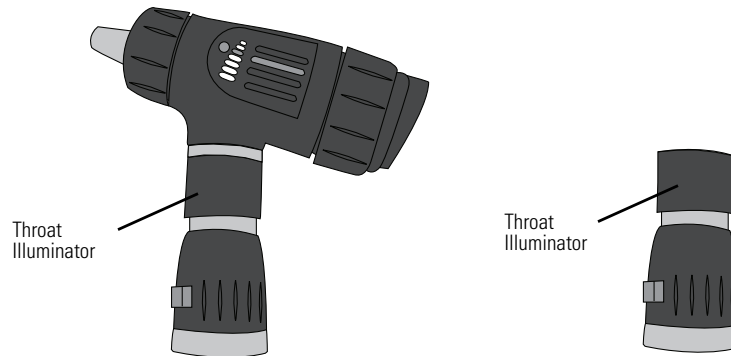

3 Maintenance and service

Replacing the lamp



Caution Halogen lamps are pressurized to provide maximum efficiency and illumination. Mistreatment may cause shattering. Protect lamp surface against abrasions and scratches. Use protective eyeglasses when handling. Dispose of lamp with care.

Caution Only use Welch Allyn lamp REF 06500-U.

Caution Lamps may be hot. Allow the lamps to cool before removing.

Caution Avoid removing the lamp for reasons other than replacement.

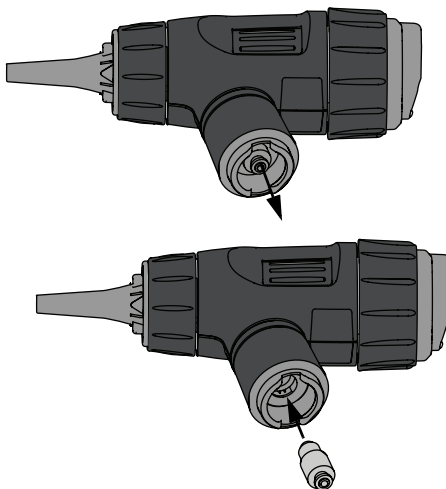

It is necessary to re-calibrate the white balance on the Digital MacroView after replacing the lamp.

To recalibrate the white balance:

Use a fully-charged 3.5v power source.

1. Connect the head to the computer and turn the power to the full on position see "Using the Digital MacroView System" on page 8.
2. Shine the light on a piece of white paper approximately 3.2 cm (1.25") away.
3. Unfold a standard paperclip and insert it into the white balance reset hole. Push slightly to activate the white balance reset button.

The image becomes blue on the computer screen. A live image returns to the computer screen when calibrated.

If the screen is red then repeat steps 1 through 3 above.

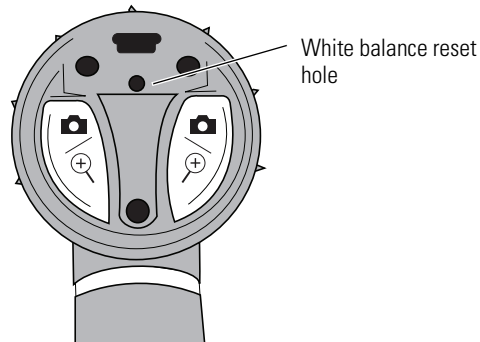

Cleaning recommendation



Caution Do not apply alcohol, chemicals, or water to the lenses. Solution entering the optical assembly could damage internal components.

Use a dry cloth to clean the Digital MacroView System monthly.

Recycling the system components

Within the EU

Do not dispose of this product as unsorted municipal waste. Prepare it for reuse or separate collection as specified by Directive 2002/96/EC of the European Parliament and the Council of the European Union on Waste Electronic and Electrical Equipment (WEEE).



If this product is contaminated, this directive does not apply.

For more specific disposal information, see www.welchallyn.com/weee, or contact Welch Allyn Customer Service.

Outside the EU

When the product and its components reach end of life, recycle it locally according to national, state, and local regulations, or return it to Welch Allyn.

Accessories

REF	Description
23900-10	Replacement USB cable, 10 ft length
23804	Insufflator bulb for MacroView
23857	3.5v Throat Illuminator section only
24302-U	Universal Poly Reusable Speculum 2.5mm
24303-U	Universal Poly Reusable Speculum 3mm
24304-U	Universal Poly Reusable Speculum 4mm
24305-U	Universal Poly Reusable Speculum 5mm
24400-U	Set of 4 Universal Reusable Speculum
52432-U	2.75mm Disposable Ear Specula
52434-U	4.25mm Disposable Ear Specula
24320	SofSeal Small, Disposable Sealing Tip
24330	SofSeal Medium, Disposable Sealing Tip
06500-U	Lamp
23920MAN/ 23960MAN	Directions for Use - CD
23920-QSG	Quick Start Guide

Service policy

All repairs on products under warranty must be performed or approved by Welch Allyn. Unauthorized repairs will void the warranty. In addition, whether or not covered under warranty, any product repair shall exclusively be performed by Welch Allyn certified service personnel.

If the product fails to function properly — or if you need assistance, service, or spare parts — contact Welch Allyn.

Before contacting Welch Allyn, try to duplicate the problem, and check all accessories to ensure that they are not causing the problem. When calling, please be prepared to provide:

- Product name and model number and complete description of the problem.
- Serial number of your product (if applicable).
- Complete name, address and phone number of your facility.
- For out-of-warranty repairs or spare parts orders, a purchase order (or credit card) number.
- For parts orders, the required spare or replacement part numbers.

If your product requires warranty, extended warranty, or non-warranty repair service, please call Welch Allyn. A representative will assist you troubleshooting the problem and will make every effort to solve it over the phone, avoiding potential unnecessary returns.

In case a return cannot be avoided, the representative will record all necessary information and will provide a Service Notification number, as well as the appropriate return address. The Service Notification number must be obtained prior to any return.

If you have to return goods for service, follow these recommended packing instructions:

- Remove all hoses, cables, sensors, power cords, and ancillary products (as appropriate) before packing, unless you suspect they are associated with the problem.
- Wherever possible use the original shipping carton and packing materials.
- Include a packing list and the Welch Allyn Service Notification number.

It is recommended that all returned goods be insured. Claims for loss or damage to the product must be initiated by the sender.

4 Specifications

Item	Specification
Weight	Approximately 95 g (0.2 lb)
Dimensions (approximate)	Height: 7.0 cm (2.8 inches) Length: 10.2 cm (4.0 inches) Width: 3.7 cm (1.5 inches)
Rating	Lamp: 3.5Vdc, 810 mA USB: 5.0Vdc, 150 mA
Protection against ingress of water	IPX0
Operating conditions	
Temperature	+10° C to +40° C (+50° F to +104° F)
Relative humidity	30% to 75% noncondensing
Altitude	700 to 1060 hPa
Shipping and storage conditions	
Temperature	-20° C to +49° C (-4° F to +120° F)
Relative humidity	95% noncondensing max.
Intermittent operation	≤ 2 minutes on, ≥ 10 minutes off between uses
Safety, EMC, and regulatory compliance	CAN/CSA C22.2 No. 601.1-M90, including amendments 1 & 2 EN/IEC 60601-1 EN/IEC 60601-1-2 UL 60601-1
Patents	Patents Pending

Limited Warranty

Welch Allyn warrants that the Digital MacroView products meet the labeled specifications of the products and will be free from defects in materials and workmanship that occur within one year after the date of purchase. Neither the lamp or specula have an explicit warranty beyond out of box failures.

The date of purchase is: 1) the date specified in our records if you purchased the Product directly from us, 2) the date specified in the warranty registration card that we ask you to send to us, or 3) the date of purchase of product from the authorized Welch Allyn distributor as documented from a receipt from said distributor.

This warranty does not cover damage caused by: 1) handling during shipping, 2) use or maintenance contrary to labeled instructions, 3) alteration or repair by anyone not authorized by Welch Allyn, and 4) accidents.

If a Product or accessory covered by this warranty is determined to be defective because of defective materials, components, or workmanship, and the warranty claim is made within the warranty period described above, Welch Allyn will, at its discretion, repair or replace the defective Product or accessory free of charge.

You must obtain a service notification number from Welch Allyn to return your Product before you send it to Welch Allyn's designated service center for repair. Contact Welch Allyn Technical Support.

THIS WARRANTY IS IN LIEU OF ALL OTHER WARRANTIES, EXPRESS OR IMPLIED, INCLUDING BUT NOT LIMITED TO THE IMPLIED WARRANTIES OF MERCHANTABILITY AND FITNESS FOR A PARTICULAR PURPOSE. WELCH ALLYN'S OBLIGATION UNDER THIS WARRANTY IS LIMITED TO REPAIR OR REPLACEMENT OF PRODUCTS CONTAINING A DEFECT. WELCH ALLYN IS NOT RESPONSIBLE FOR ANY INDIRECT OR CONSEQUENTIAL DAMAGES RESULTING FROM A PRODUCT DEFECT COVERED BY THE WARRANTY.

4341 State Street Road, PO Box 220, Skaneateles Falls, NY 13153-0220 USA
1 800 535 6663, + 1 315 685 4560 www.welchallyn.com

WelchAllyn®

Advancing Frontline Care™

Reorder No. 23920MAN/23960MAN

80012182 Ver. F